

# PRODUCT CATALOGUE

2020-2021 - Version 5.5

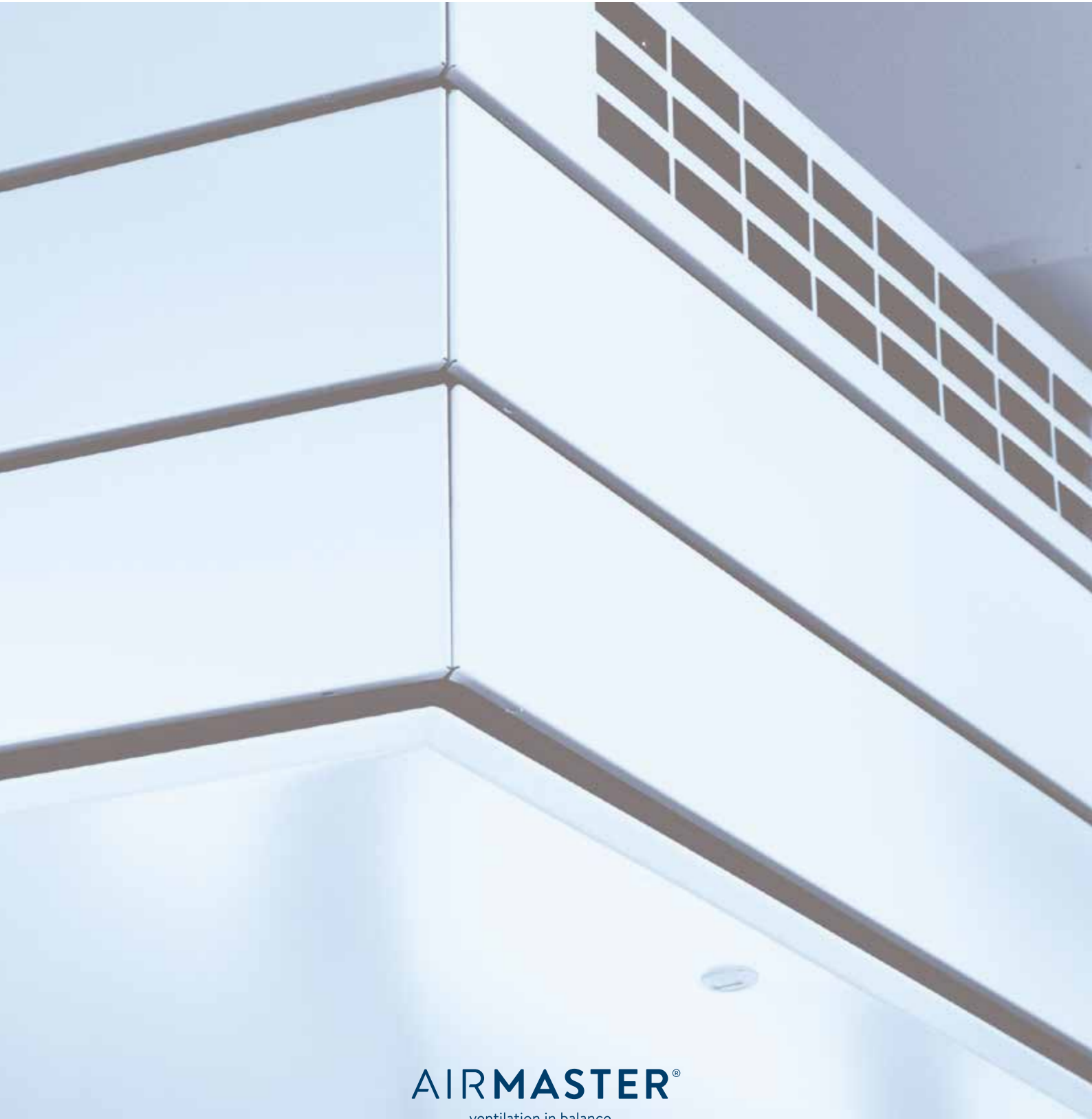

**AIRMASTER®**  
ventilation in balance

# KNOW THE FEELING?

Stuffy, warm air. Your eyes are dry and itchy. Your head feels heavy and you find it hard to concentrate.

“A poor indoor climate has a lot of influence on our comfort and wellbeing. Research indicates that a poor indoor climate has a negative effect on our performance level of 5-10%. Children are affected even more.” \*

That's why we need world class indoor climate.

---

*\*Geo Clausen, International Centre for Indoor Environment and Energy, Technical University of Denmark*





## CONTENT

An optimum CO <sub>2</sub> -level improves learning and health .....	4
Ventilation in balance .....	6
Intelligent ventilation .....	7
Horizontal or vertical model .....	8
Decentralised ventilation - a wide range of applications .....	10
Airmaster inlet stream principles .....	14
Correct placing .....	16
Control processes .....	20
Control processes for cooling .....	23
Control processes with sensors .....	26
Modulating VOC-sensor .....	27
Control via motionsensors (PIR) .....	29
Control processes with hygostat .....	30
Performance testing of ventilation units .....	31
AM 150 .....	33
AM 300 .....	39
AM 500 .....	53
CC 500 .....	85
AM 800 .....	61
CC 800 .....	66
AM 1000 .....	69
AM 900 .....	77
AM 1200 .....	85
DV 1000 .....	97
CC 1000 .....	100
Intelligent control with Airlinq® .....	102
Control functions with Airlinq® .....	103
Airlinq® Orbit control panel .....	104
Airlinq® Viva control panel .....	106
Network with Airmaster .....	108
Airmaster Airlinq® Online .....	110
Airlinq® Online / Airlinq® Online API .....	111
Ventilation grill - Boomerain® Ø160, Ø250 & Ø315 .....	112
Installation and fittings .....	113
Technical data overview .....	118
Filter standard - ISO 16890 .....	127

# AN OPTIMUM CO<sub>2</sub>-LEVEL IMPROVES LEARNING AND HEALTH

We have all experienced entering a room in which the air feels close and stuffy. Air consists of a number of elements, of which oxygen, nitrogen and CO<sub>2</sub> are the largest. There has to be a natural balance between them.

An increase in the level of CO<sub>2</sub> is an indication of human activity. Human activity is good, but the "used" air has to be replaced with fresh air to restore the natural balance.

The level of CO<sub>2</sub> tells us whether sufficient fresh air is being supplied in relation to the number of people in the room. If you are exposed to an excessively high level of CO<sub>2</sub>, it can affect your health, including:

- Headaches
- Vertigo
- Fatigue
- Restlessness
- A tingling sensation in the legs
- Difficulty breathing
- High blood pressure

## DIFFERENT CO<sub>2</sub>-LEVELS:

### 400-1000

400-1000 ppm is considered the normal CO<sub>2</sub> level for rooms with a good supply of fresh air.

### 1000-2000

At a level of 1000-2000 ppm, you will typically begin to feel tired and have difficulty concentrating.

### 2000-5000

At a level of 2000-5000 ppm, you will typically suffer headaches, feel sleepy and generally unwell.

### 5000-

At a level of 5000 ppm or above, there is a risk of fainting due to CO<sub>2</sub> poisoning.



Airmaster has developed compact measuring stations for test measurement. We offer free, non-obligatory test measurements of your indoor climate.

### A COMMON EXAMPLE

CO<sub>2</sub> measurements performed in a traditional classroom at Gl. Hasseris School, clearly show how important good ventilation is for air quality.

The blue line shows the CO<sub>2</sub> level with an Airmaster unit in operation. The red line shows readings taken in the same room without ventilation.

The figure shows readings taken over five weekdays.

The results are clear to see. Without ventilation, the CO<sub>2</sub> level reaches 2000 ppm within a single hour of lessons. Given the number of hours spent in daycare, schools and at work, this is a thought provoking and disturbing result.

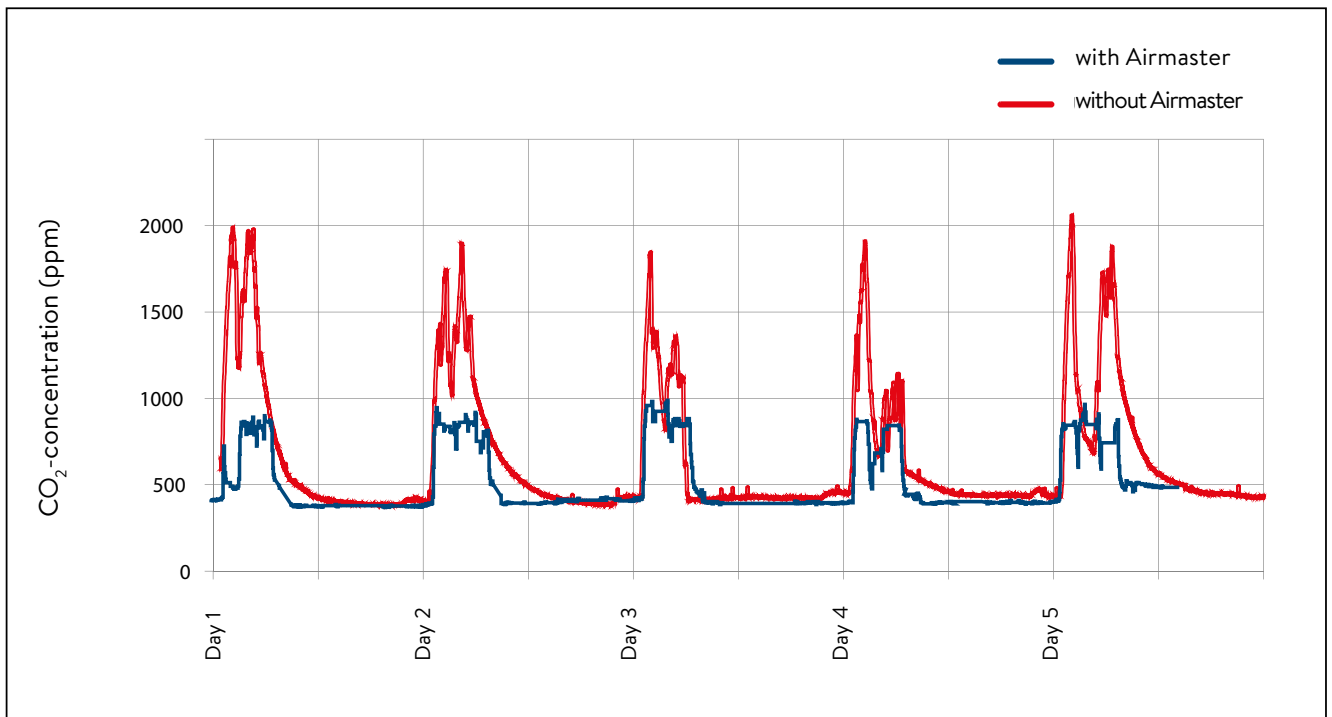

# VENTILATION IN BALANCE

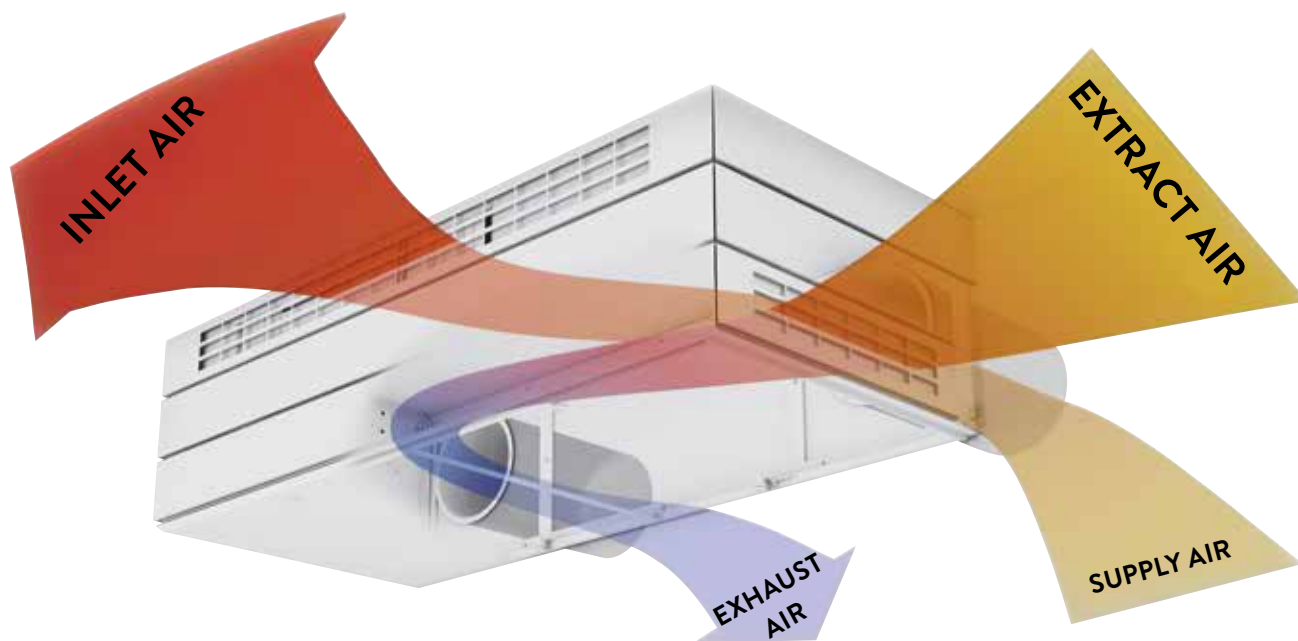

Fresh air is a human right. And that's why Airmaster has developed the most energy-efficient and quiet, decentralised ventilation solutions on the market with heat recovery - solutions which can be used in all types of rooms and buildings.

Airmaster's decentralised ventilation solutions keep energy consumption for ventilation and heating in a building to a minimum. Only those rooms where and when ventilation is needed are serviced. No wasted energy on unnecessary ventilation.

# INTELLIGENT VENTILATION

## LOW ENERGY CONSUMPTION

The decentralised air handling unit with counter-flow heat exchanger is placed in the room close to an outer wall. The very short distance extracted air has to travel combined with the counter-flow heat exchanger located alongside means very low energy consumption. No need for long ventilation ducts, meaning minimum heat loss (transmission loss). Decentralised ventilation supplies an individual room without being difficult or expensive to install.

## EFFICIENT EC MOTOR TECHNOLOGY

Airmaster uses energy-efficient EC motors, which give low energy consumption, flexible adjustment and silent operation.

## HIGH HEAT RECOVERY

We use highly-efficient counter-flow heat exchangers, and document temperature ratio in accordance with European standard EN 308:1997<sup>1</sup>, which is a dry temperature ratio, under conditions in which condensation of return air does not occur.

Airmaster's counter-flow heat exchangers perform up to 85% measured as a dry temperature ratio in accordance with EN 308:1997, and up to 95% if condensation is included.

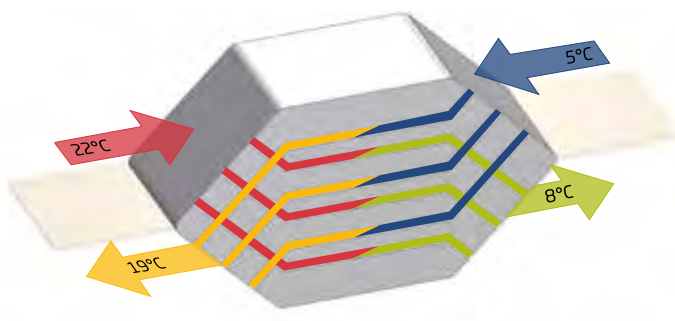

## NO DRAUGHTS OR COLD AIR DISCOMFORT

Airmaster's decentralised air handling units are all fitted with motor-controlled air dampers for the supply and extract air. When the unit is inactive, the motor-controlled damper is closed against direct air access. Cold outdoor air cannot pass through the unit into the room. Similarly, warm air cannot pass through to the outdoors.

## CONTROL WITH AIRMASTER'S CLOUD SOLUTION

Airmaster's "Airlinq Online" cloud solution allows you to monitor Airmaster ventilation units centrally and gain a quick overview of the operating status, CO<sub>2</sub> level, etc. It is also possible to integrate control of the ventilation units into your BMS using the Airlinq Online API

## SIGNIFICANT ADVANTAGES OF AIRMASTER SOLUTIONS

An Airmaster decentralised ventilation solution often has many advantages over a centralised solution. This is seen in the cost of purchasing the unit, the overall economy and resource consumption. Decentralised ventilation also uses less energy because it is demand-controlled on a room-by-room basis, with the supply and exhaust led directly through the outer wall or roof. There are therefore no ducts for the air to be pressed through, which takes pressure and thus uses energy.

In short:

- Cost- and energy efficient ventilation
- Advantages when it comes to resource consumption and recycling
- Low noise – Airmaster is the market leader in the sound performance of decentralised ventilation solutions
- Advantages when it comes to fire regulations
- Short installation time – one room at a time
- Simple servicing. Recommended once a year, depending on the usage pattern and setting
- Complete control and monitoring with Airmaster's IoT, "Airlinq online"

### 1 Test conditions:

Ambient temperature	5°C - relative humidity; 50% RH
Extract temperature	25°C - relative humidity; 28% RH
Airflow, test range	50-150% of the nominal airflow - relative humidity; 50% RH
Internal/external air emission	<3% of the nominal airflow inlet and extract are the same.



# HORIZONTAL OR VERTICAL MODEL

## Choosing the right unit

The AM series consists of wall/ceiling-hung and floor-standing air handling units. Both types come in two models: horizontal and vertical, indicating where the supply and exhaust are located. On the new Airmaster AM 300, for example, there is also the option of supply and exhaust in the side, increasing flexibility. The wall/ceiling-hung models are available in versions that can be integrated into the ceiling structure.

### WALL-MOUNTED



#### Horizontal model

Supply and exhaust pass horizontally out of the unit and through an outer wall. A louvred grille is mounted on the facade side.



#### Vertical model

Supply and exhaust pass vertically up through the roof. Roof Caps and covers are used at the end of the duct.



#### Side model

The supply and exhaust are led out of the unit on the left and right side respectively, and through the outer wall or up through the roof.

### FLOOR-STANDING UNIT

Floor-standing units can be placed along a wall, away from a wall or freestanding, e.g. as a room divider.



#### Horizontal model

Supply and exhaust pass horizontally through an outer wall.



#### Vertical model

Supply and exhaust pass vertically up through the roof.

**PARTIALLY INTEGRATED UNIT**



**Horizontal model**

Horizontal model with 1/3<sup>rd</sup> of the unit integrated into a ceiling.



**Horizontal model**

Horizontal model with 2/3<sup>rd</sup> of the unit integrated into a ceiling.



**Vertical model**

Vertical model with 1/3<sup>rd</sup> of the unit integrated into a ceiling.



**Vertical model**

Vertical model with 2/3<sup>rd</sup> of the unit integrated into a ceiling.

**SIDE MODEL**

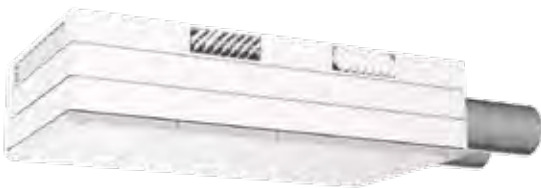

**Side model**

Supply and exhaust pass sideways out of the unit. Only possible on the AM 1000 unit.



**Side model**

The supply and exhaust are led out of the unit on the left and right side respectively, and through the outer wall or up through the roof. Only available for the AM 300 unit.

This floor-mounted units can be placed along a wall and supply air at ground level (displacement) or at ceiling level (mixed).

Available as either a horizontal or vertical model.



**Horizontal model**

Supply and exhaust pass horizontally through an outer wall.



**Vertical model**

Supply and exhaust pass vertically through the roof.

# DECENTRALISED VENTILATION -

A WIDE RANGE OF APPLICATIONS

Decentralised ventilation allows you to install ventilation in small stages, in buildings with special challenges or throughout buildings.

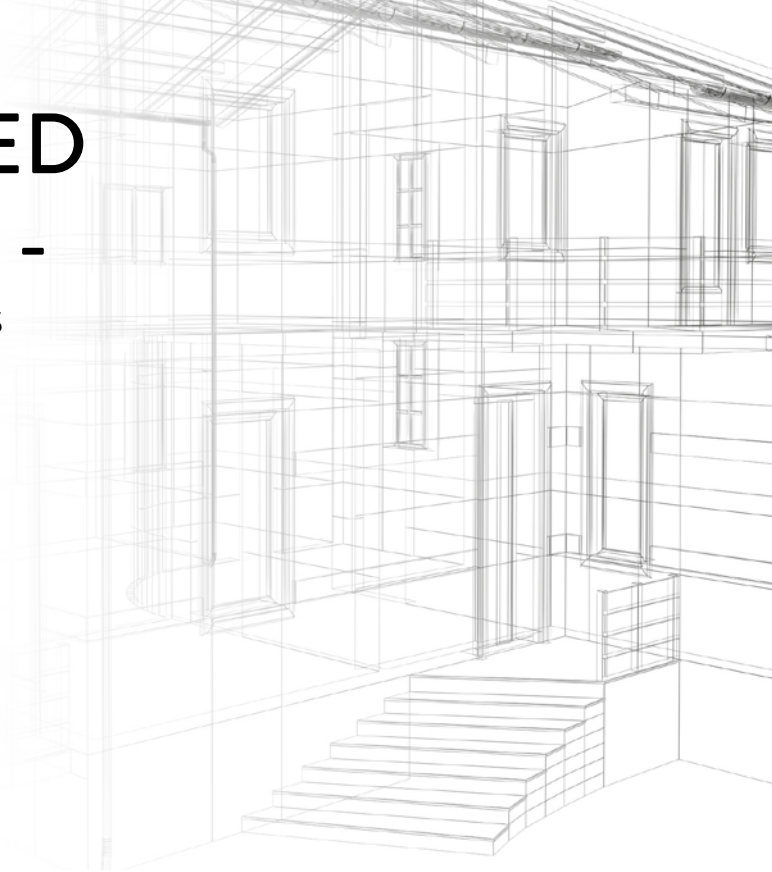

1

In a large building, where ventilation only has to be installed in a few rooms that are spread apart.

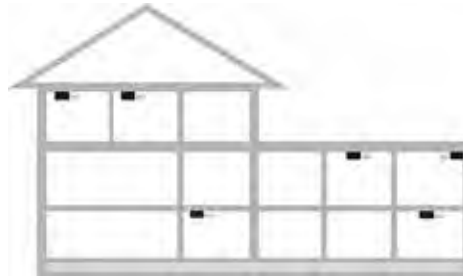

2

In a building extension, where the existing ventilation system cannot be extended.

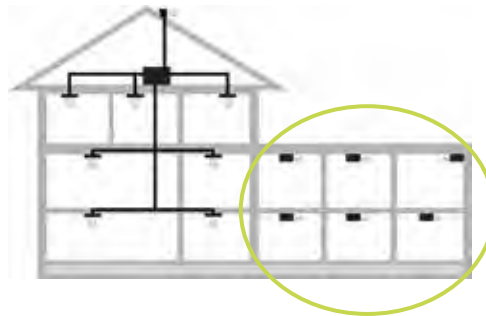

3

In a building with a flat roof.

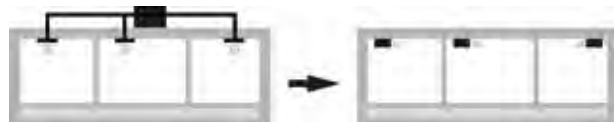

4

When total ventilation is required in a new building or in a renovation.





Photograph: Troldekt

## VENTILATION CEILING

An Airmaster air handling unit can also be integrated above a ventilation ceiling, with only its service hatch visible.

All wall-mounted models can be integrated above a ventilation ceiling, where the inlet air is blown across the ceiling and the air flows down into the room through the ventilation ceiling.

Additional airflow does not need to be calculated with this solution. It will be the same with or without the ventilation ceiling.

The extract air is extracted via an extraction unit in the ceiling.

*Photograph: Tranbjerg School's "Grønløkke" campus. An AM 800 air handling unit, installed above a ventilation ceiling with extraction unit at the side.*







# AIRMASTERS

## INLET STREAM PRINCIPLES

### COANDA EFFECT

The fresh supply air tends to run along the ceiling, before slowly descending - known as the Coanda effect. The Coanda effect mixes fresh air with ambient air and then slowly descends into the room.

### MIXING PRINCIPLE

The Coanda effect causes the stream to stick to the ceiling. The fresh air is blown in at a relatively high velocity. The air in the room is pushed along to ensure effective mixing of fresh and ambient air. The entrainment of the room air and ambient air ensures uniform air quality in the room, whilst reducing the velocity of the supply inlet stream. Consequently, draughts are avoided in the room.

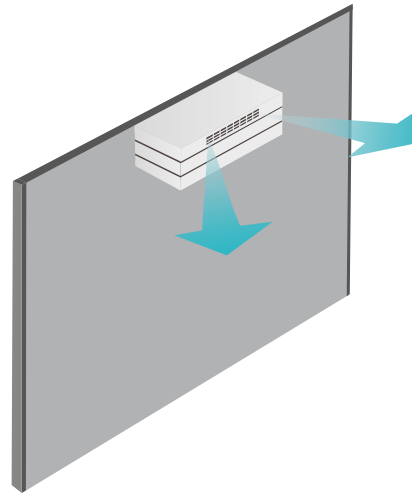

Wall-mounted Airmaster ventilation. The inlet air pattern must / can be adjusted according to the room.

### INLET STREAM FOR WALL-MOUNTED UNITS

All wall-mounted models ventilate according to the mixing principle, in which fresh air is fed into the room at ceiling level, exploiting the Coanda effect.

The AM 1000 air handling unit is available with an adaptive inlet, which adjusts the throw in relation to the airflow relative to the length of the room.

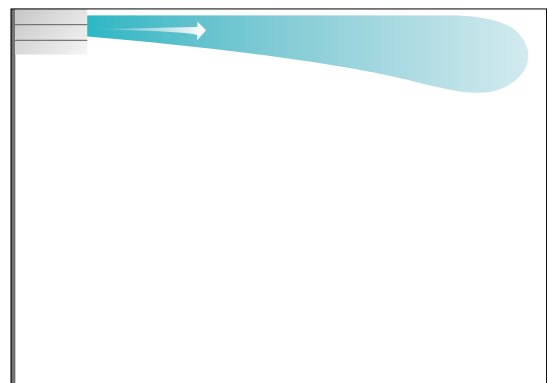

Wall-mounted Airmaster ventilation with inlet stream seen from the side.

**INLET STREAM FOR FLOOR-STANDING UNITS**

The mixing principle is also used for Airmaster’s floor-standing models (AM 900, AM 1200), with fresh air fed upwards into the room to exploit the Coanda effect.

**ADJUSTABLE INLET OPENING**

Floor-standing models AM 900 and AM 1200 are fitted with adjustable inlet openings. The opening can be adjusted according to requirement, ensuring the right throw length according to the size of the room. The throw and the supply pattern can be adjusted by adjusting the supply slats.

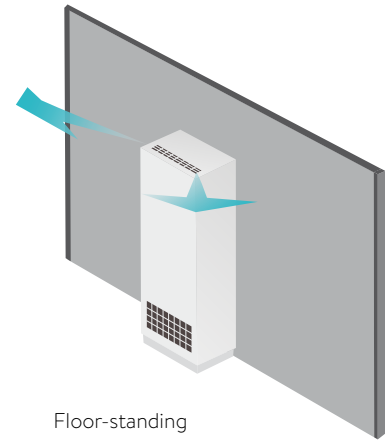

Floor-standing AM 900 - mixed ventilation.

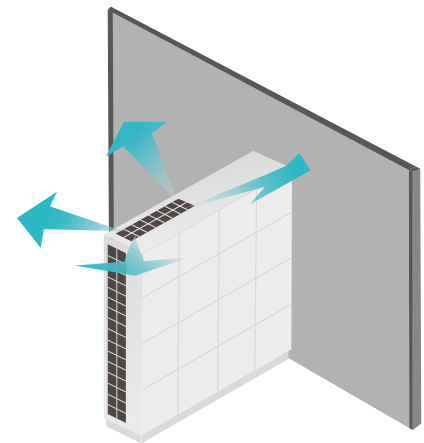

Floor-standing AM 1200 placed at right-angles to a wall as a room divider. Airflow and direction are adjusted using the louvred grille.

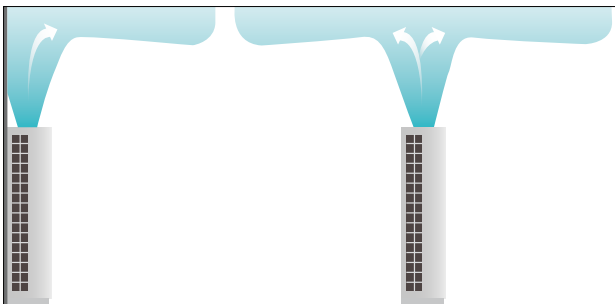

The illustration shows two floor-standing AM 1200, one standing close to a wall and the other freestanding. Inlet viewed from the side.

**THE DISPLACEMENT PRINCIPLE**

Airmaster’s floor-standing model AM 900 is also available as a displacement model. The displacement ventilation principle feeds fresh air into the room at low velocity at floor level. The fresh air is blown in at a temperature a couple of degrees lower than the room temperature.

The air is distributed over the entire floor due to the difference in density between cold and warm air. The low inlet velocity avoids draughts in the room.

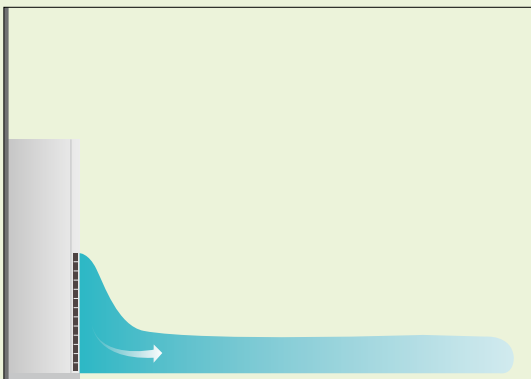

Floor-standing AM 900 - displacement ventilation with inlet stream seen from the side.

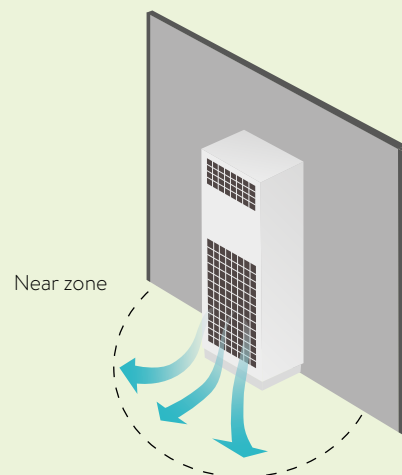

Floor-standing AM 900 - displacement ventilation.

# CORRECT PLACING

To gain the full benefit of Airmaster units, they must be correctly positioned in relation to the physical geometry of the room.

- 1 Two smaller units can be appropriate for a long, narrow room, where the throw length is too short longitudinally, yet too long laterally.

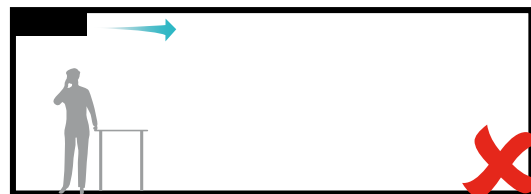
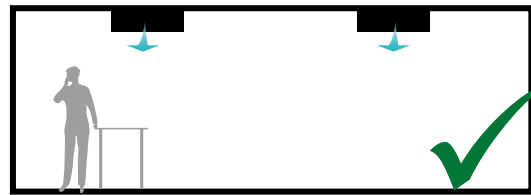

- 2 If the room has a high or sloping ceiling, the units should be mounted as high as possible.

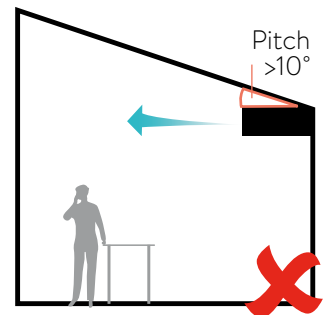
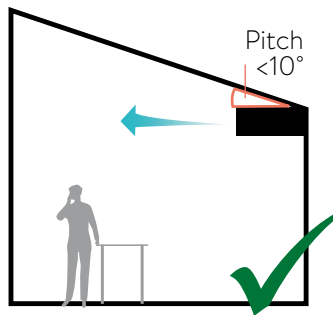
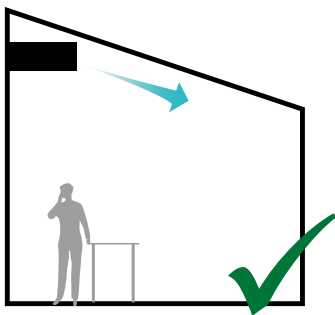

3

To achieve the most effective inlet, objects that could obstruct the path of the air should be avoided, such as light fittings mounted directly on the ceiling. Light fittings should be lowered to allow the air to circulate freely around the room.

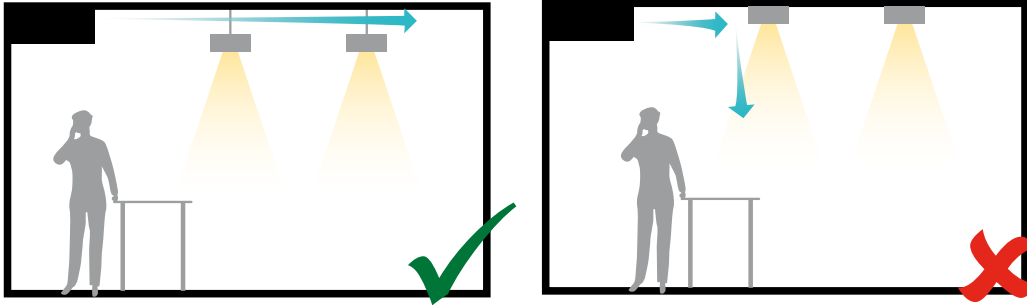

4

In rooms where the occupants are physically close to a unit, it is important to use wall-mounted or floor-standing models according to the mixing principle to avoid draughts.

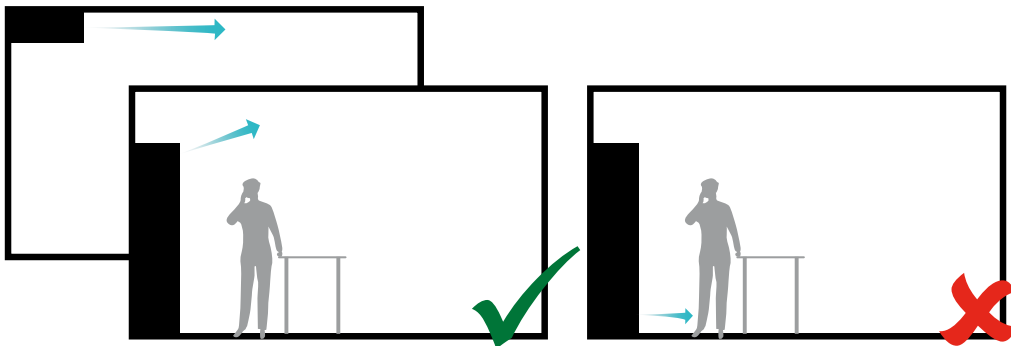

5

If there are ceiling beams in the room that can obstruct the air current, choose a floor-standing unit that ventilates according to the displacement principle (AM 900 D), or a wall-mounted unit that ventilates along the length of the room.

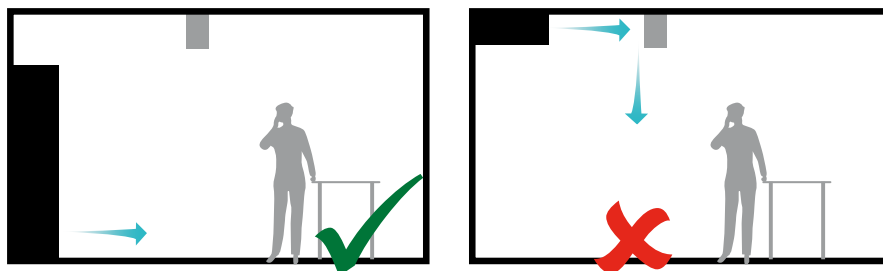



# CORRECT PLACING

WITH REGARD TO ACOUSTIC PRESSURE

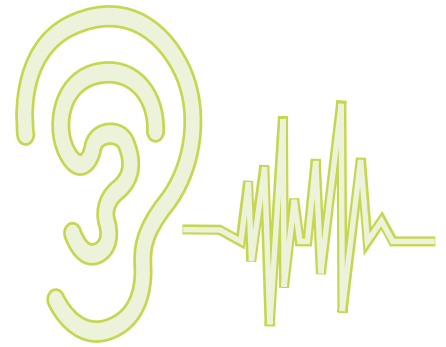

## SECTIONAL VIEW

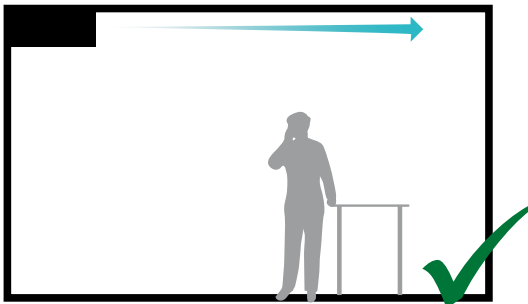

System mounted against the ceiling and wall.

To gain maximum out of your Airmaster unit you should be aware of the following details. These diagrams can be used as a guideline and a tool for effective acoustic installation.

## SECTIONAL VIEW

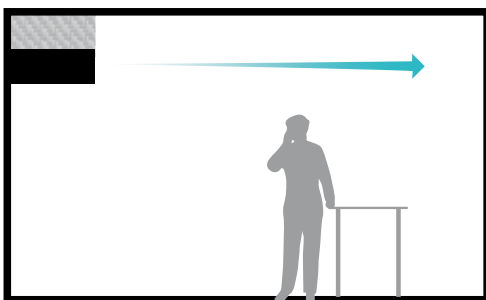

System mounted against the wall but away from the ceiling.

- ⚠ The top plate is sound insulated, and visible pipes are insulated against condensation. The space between the unit and the ceiling can possibly be boxed in.

## SECTIONAL VIEW

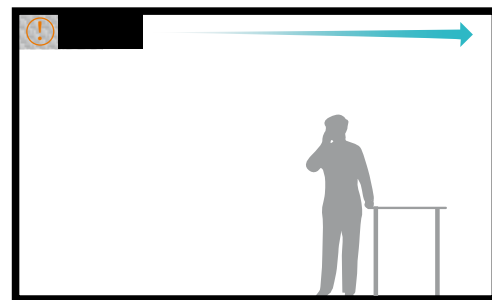

System mounted against the ceiling at a short distance from the wall.

- ⚠ The back plate is sound insulated, and visible pipes are insulated against condensation. The space between the unit and the wall can possibly be boxed in.

## TOP VIEW

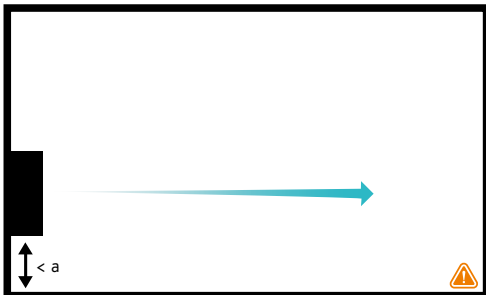

System mounted with a short distance from extract to the side wall.

a: min. 0,5 m for AM 150-800  
min. 1,5 for AM 1000

## TOP VIEW

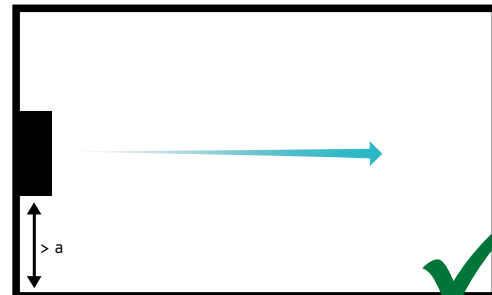

System mounted with a further distance from extract to the side wall.

a: min. 0,5 m for AM 150-800  
min. 1,5 for AM 1000

⚠ Additional calculations and measures may be expected. Contact Airmaster.



Sound is an important part of comfort ventilation and it is a challenge that Airmaster has solved.

Airmaster is Europe's leading supplier of decentralised comfort ventilation, providing solutions to public sector institutions and private companies.

Airmaster has installed more than 70,000 air handling units since it launched a new generation of Airmaster air handling units in 2005.

The company's continued rapid development has led to the further introduction of new models and new technology.

Airmaster employs around 100 people, and about 20% of its workforce are engineers and technicians working in development and in the product department – all of them with their own specialist fields and includes an acoustic engineer.

The R&D department has its own advanced test and development facilities with a climatic chamber, where in addition to development work, we also test customer-specific setups and user scenarios.

Airmaster collaborates with educational and research institutions on an ongoing basis, at a national and international level, in order to provide decentralised high-quality ventilation units with heat recovery – future-proof solutions with low sound and low energy consumption.



# CONTROL PROCESSES

To follow is a look at the different advanced control processes.

## DEALING WITH CONDENSATE

With the high level of heat recovery of up to 95%, extract air in the counterflow heat exchanger undergoes intense cooling.

This may, under certain conditions, cause moisture in the extract air to condense in the exchanger. If this occurs, the condensation will then be collected in a condensation tray, where a swimmer automatically records how much water there is. The unit is fitted with an automatic condensation management process, which means that in rooms with normal humidity, such as offices, meeting rooms and classrooms, it is not typically necessary to connect a condensation drain.

When ventilating rooms with high humidity, the condensation can be directed away from the unit to a drain to prevent outages, for example by fitting the unit with a fully automatic condensation pump.

## FROST PROTECTION

When the outside temperature approaches freezing point, the exhaust temperature behind the counter-flow heat exchanger drops. This can result in condensate freezing in the heat exchanger. The Airlinq control system prevents the formation of ice by increasing extract air and reducing inlet air, causing the extract air temperature to rise again.

If this process is insufficient to prevent ice forming in the heat exchanger, Airlinq will protect the unit by shutting down operation.



### FLOAT

Built-in float sensor detects unwanted build-up of condensate.

### ”PREHEAT” WITH ELECTRIC PREHEATING SURFACE

If the air handling unit is fitted with an electric preheating surface, it will heat the fresh air before it meets the counter-flow heat exchanger, preventing the formation of ice. To maintain balanced ventilation, the Airlinq control system controls the temperature in the unit. This is achieved by the preheating surfaces only cutting in if the requirement exists. Energy consumption can thus be kept at a minimum.

### ”VIRTUAL PREHEAT” WITH ELECTRIC HEATING SURFACE

On AM 150 and DV 1000, the unit can alternatively be protected against ice formation by using an electric heating element and the “virtual pre-heating” function. A bypass damper diverts some of the fresh air past the counter-flow heat exchanger. The heating surface heats the fresh air up to the inlet temperature is reached. The extract air is cooled down less in the heat exchanger, preventing ice formation.



#### ELECTRIC PREHEATING SURFACE

Optional preheating surface for very cold areas.

### CONTROLLED INLET TEMPERATURE

To achieve the highest level of heat recovery, Airmaster air handling units are fitted with highly-efficient counter-flow heat exchangers. A comfort current is therefore used only to equalise the minimal heat loss from ventilation. A heating element is therefore only used to offset the minimal heat loss during ventilation, ensuring that full operation can be maintained, even in cold geographical regions.

Balanced ventilation is maintained as long as the inlet temperature remains within acceptable limits as standard.

If the inlet temperature cannot be maintained at low fresh temperatures, Airlinq will reduce inlet air and increase extract air to compensate for the low temperature.

The function is also active if comfort heating surface capacity is utilised 100%.

This function means that in certain climates the comfort heating surface is not required.

### ELECTRIC COMFORT HEATING SURFACE WITH ADAPTIVE CONTROL

The electrical comfort heating surface is controlled automatically by the Airlinq controls system, which checks the temperature conditions in the air handling unit and switches on/off the comfort heating surface as required.

Adaptive control means that the electrical comfort heating surface warms the inlet air after the counter-flow heat exchanger with only the energy required to maintain the desired inlet air temperature. In other words, adaptive control ensures that the supply air has an even temperature.

The balance between the supply air and extract air can be maintained via an electrical comfort heating surface, even at very low outdoor air temperatures.

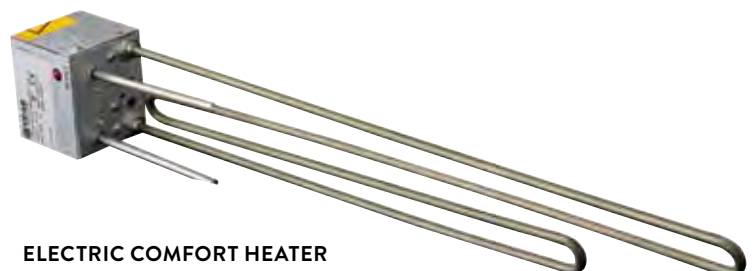

#### ELECTRIC COMFORT HEATER

# CONTROL PROCESSES

## WATER HEATING SURFACE

Most air handling units can have a water heating surface fitted as an alternative to an electric comfort heating surface. A water heating surface also ensures the required inlet temperature. The large surface area of the heating surface ensures efficient transfer of heat energy to the inlet air.

The Airlinq control system starts and stops the heating surface using a motor-driven valve. The heating surface is supplied built-in to the air handling unit, or as part of the duct system. Connection to the local heating system is therefore quick and simple.

## FROST PROTECTION OF WATER HEATING SURFACE

The water heating surface is fitted with a separate, self-controlling heat retention valve, which ensures a minimum temperature even when the air handling unit is switched off. All nominal values for the water heating surface are preprogrammed into the Airlinq control system. The heating surface is therefore protected against frost and is directly functional.

## FLOW CONTROL

Most air handling units can control the airflow using flow control. Flow control means that the airflow is stated in  $\text{m}^3/\text{h}$  and ensures balanced operation, at varying pressure difference on the supply and extract air. To convert airflow to  $\text{m}^3/\text{h}$ , a measuring nozzle is fitted inside the air handling unit between the fan and the main box, which measures the differential pressure. The differential pressure is measured for the supply air and extract air respectively, and then converted to an airflow in  $\text{m}^3/\text{h}$ .

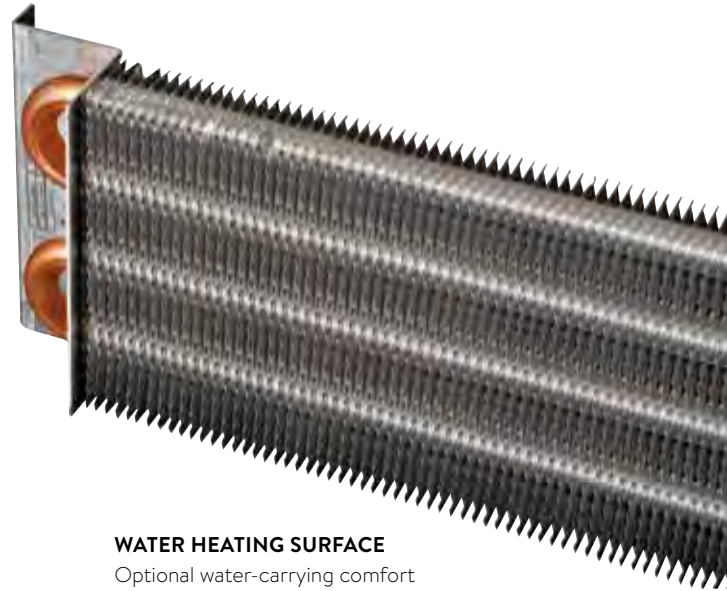

## WATER HEATING SURFACE

Optional water-carrying comfort heating surface.



# CONTROL PROCESSES FOR COOLING

Although not a heating or air conditioning unit as such, an Airmaster ventilation unit can still help regulate the room temperature to a certain degree. The fully automatic control will utilise the outdoor temperature for cooling when it is lower than the room temperature, both by bypassing the heat exchanger and through night cooling. If additional cooling is needed, most Airmaster ventilation units can have a cooling module added, which can further reduce the temperature of the supply air. The specially developed cooling modules are designed to lower the temperature of the outside air by up to 15°C and ensure the most comfortable supply temperature. The cooling modules are demand controlled and only cool the air to the extent necessary and when needed.

## **AUTOMATIC BYPASS**

The Airlinq control system can open the bypass gradually if the inlet temperature exceeds the required level. Cooler fresh air will be allowed to bypass the counter-flow heat exchanger, ensuring that the inlet temperature set is maintained. Airlinq will adjust the inlet air temperature to achieve a higher cooling output. If the room temperature exceeds the level set, e.g. as a result of strong sunshine, the bypass will open automatically.

If a cooling module is fitted to the air handling unit, Airlinq will activate it automatically if cooling using fresh air is insufficient.

## **NIGHT TIME COOLING**

If the room temperature exceeds the maximum level set during the day, all Airmaster air handling units can automatically cool down the room using colder night air. It will be registered by the Airlinq control system, and started automatically.

If necessary, the function will use the bypass damper and cooling module to achieve the cooling output required. The building and its contents will be cooled, and a reduction of the room temperature will be achieved for the next day.

# CONTROL PROCESSES FOR COOLING

## ENERGY-EFFICIENT AND ON-DEMAND COOLING

Airmaster inverter-controlled cooling modules provide efficient and on-demand controlled ventilation and cooling solutions with extremely low-energy consumption in rooms where air-replacement and cooling needs vary.

The inverter-controlled cooling modules are integrated with Airmaster decentralised air handling units.

## COOLING USING INVERTER-CONTROLLED COOLING MODULES (CC)

At high outdoor air temperatures, the bypass function and night cooling ensures that the supply air temperature is kept to the desired level. If the cooling level is insufficient, the temperature can be reduced efficiently using the cooling module.

The Airlinq control system automatically activates the cooling module, which can reduce the outdoor air temperature by up to 15°C.

The cooled air is fed into the air handling unit and the supply air temperature is thus kept to the desired level.

All cooling modules are dimensioned in accordance with European conditions (outdoor air temperature 35°C, 40% relative humidity) and standard EN 14511-2.

The cooling module is not subject to the PED – Pressure Equipment Directive in accordance with article 1 (3.6).

All cooling modules are equipped with a built-in condensation pump as standard.

Airmaster specially developed inverter-controlled cooling modules are fully automatically controlled by the Airlinq control system.

Together with five network modules (Airlinq® Online, LON®, MODBUS® RTU RS485, BACnet™ MS/TP, BACnet™/IP, KNX®) and the intuitive control panels, Airlinq supports an efficient, economical and future-proof ventilation solution.



## CC COOLING MODULE

is available for the following air handling units:  
AM 150 H (launch Q2 2020)  
AM 300 H (Fits gen. 2)  
AM 500 H  
AM 800 H  
DV 1000

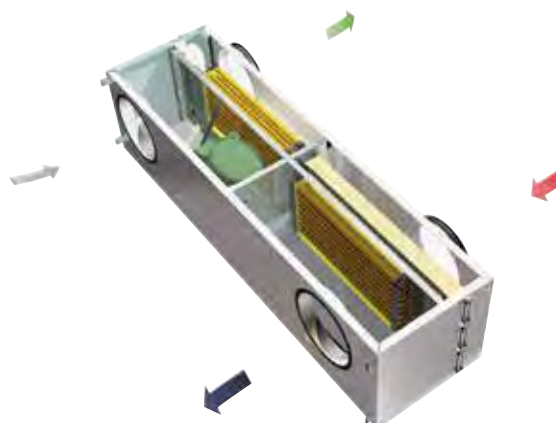

Airmaster's comfort-creating cooling module for horizontal models completes the most flexible ventilation system on the market.

**BENEFITS IN TERMS OF RUNNING COSTS AND CLIMATE IMPACT ARE GAINED BY THE DEPLOYMENT OF PIONEERING TECHNOLOGY.**

An inverter-controlled cooling solution gives infinitely adjustable capacity regulation of the compressor, to ensure that it adjusts constantly to actual cooling requirement. That means significant benefits in terms of running costs and climate impact:

- Optimised for energy-efficient operation in our climate zone.
- Improved annual mean EER value due to inverter-controlled compressor.
- Lower running costs thanks to on-demand control - annual savings for electricity typically 60-80%.
- Intelligent inverter control ensures continuous operation, even under extreme climatic conditions, indoors and outdoors.
- Very quiet in operation.
- Uses the highly effective coolants R410A or R134A that do not contribute to ozone loss.
- Outdoor air is typically cooled by 15°C before entering the room via the Airmaster unit.
- Easy monitoring of operation and climate via Airlinq data log - stores up to one year's operating data.

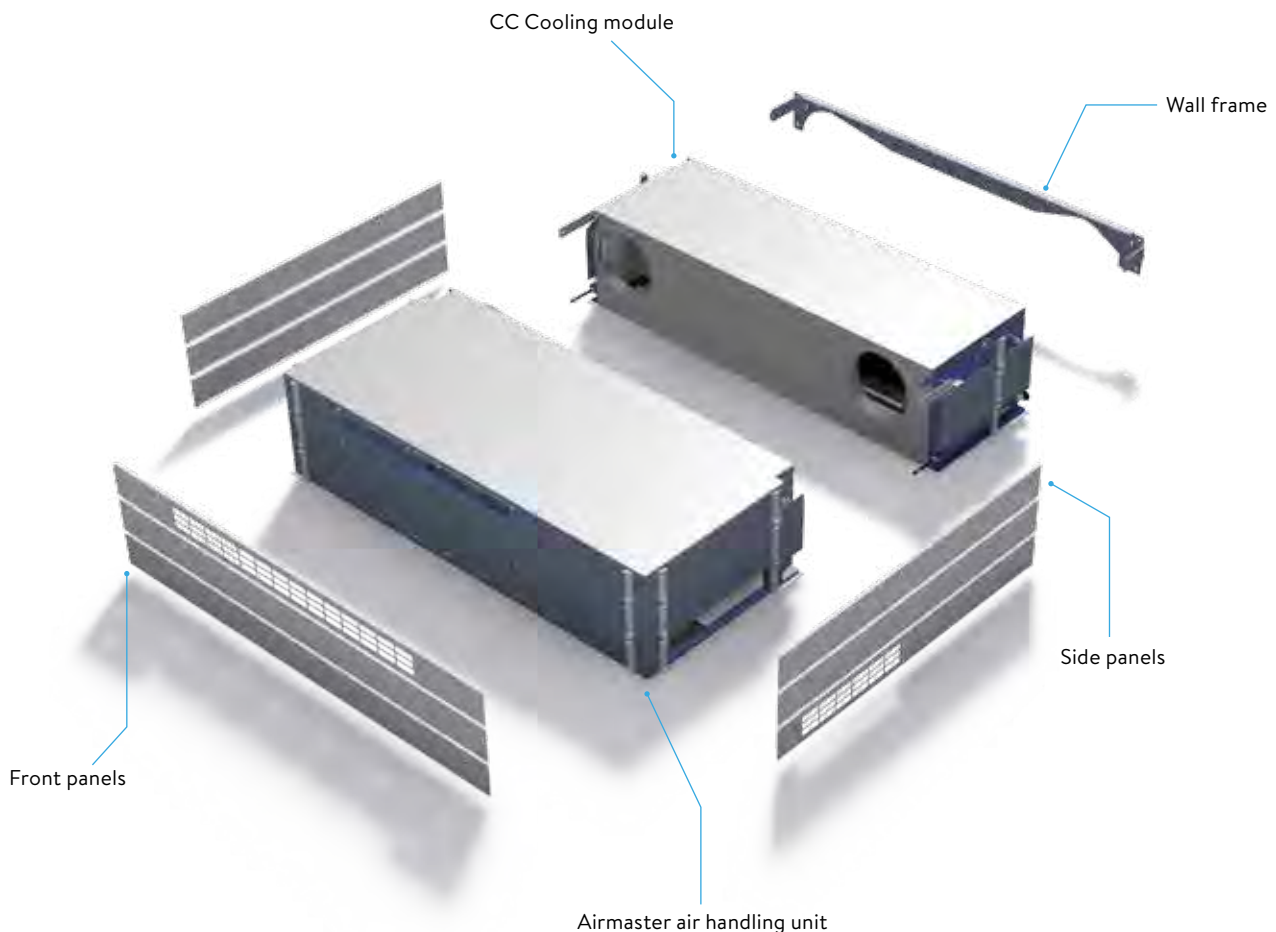

# CONTROL PROCESSES WITH SENSORS

Demand controlled ventilation can be obtained by means of various sensors. Controlling ventilation according to need provides both a high level of indoor air quality and reduces energy consumption.

## CONTROL VIA CO<sub>2</sub> SENSOR

In rooms where humans are the primary source of pollution, comfort ventilation is often controlled according to the CO<sub>2</sub> concentration in the room as it is a good indicator of pollution caused by people and thus the need for a supply of fresh outdoor air. A CO<sub>2</sub> sensor measures the CO<sub>2</sub> level in the room, and sends the reading to the control system. The control system then adjusts the rate of air replacement in the room according to the CO<sub>2</sub> level, The unit's energy consumption is reduced to the minimum.

## AIRFLOW CONTROL (FIGURE 1)

The unit can be set to run with a reduce standard airflow (min.) for basic ventilation. If the CO<sub>2</sub> level in the room exceeds the programmed lower limit (A), the CO<sub>2</sub> sensor will cut in and increase airflow.

If CO<sub>2</sub> levels continue to rise, the airflow will be increased linearly up to the maximum volume (max.) at the upper CO<sub>2</sub> limit (B) and above.

## START, STOP AND AIRFLOW CONTROL (FIGURE 2)

If the air handling unit is fully controlled by a CO<sub>2</sub> sensor, it will start with standard airflow once the CO<sub>2</sub> level exceeds the programmed limit, plus + 10% (A + 10 %).

If the CO<sub>2</sub> level continues to increase in the room, the airflow is increased linearly, up to the maximum airflow at the CO<sub>2</sub> level's upper limit (B) and above.

If the CO<sub>2</sub> level falls below the programmed lower limit (A), the air handling unit stops again.

If the air handling unit is started by a timer and the CO<sub>2</sub> limit continues to exceed the lower limit (A), the air handling unit will continue even after the programmed stop, until the CO<sub>2</sub> level has fallen below the lower limit, to ensure a good indoor climate.



## CO<sub>2</sub> SENSOR - WALL-MOUNTED OR BUILT-IN

Automatically aligns the ventilation level to the CO<sub>2</sub> level in individual rooms.

FIGURE 1  
AIRFLOW CONTROL

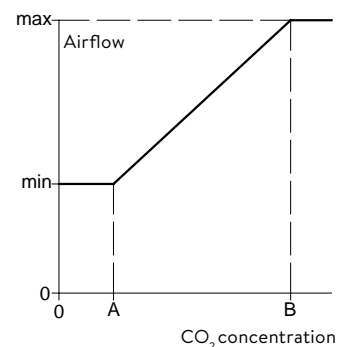
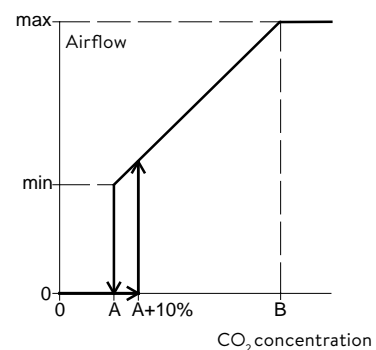

FIGURE 2  
START, STOP AND AIRFLOW CONTROL



# MODULATING VOC-SENSOR



## Newly developed demand control of the indoor climate

Working with the Danish Technological Institute and funded by Realdania, Airmaster has furthered its quest for a good indoor climate by developing a modulating demand control of Airmaster ventilation units, based on a VOC sensor.

Research shows that the CO<sub>2</sub> concentration is not the only thing to cause impaired concentration and the like, but that other gases such as formaldehyde, acetone, methanol, acetic acid and acetaldehyde – called VOCs (Volatile Organic Compounds) – have a decisive influence.

VOCs are easily evaporable organic compounds released by cleaning agents, building materials, work processes, cosmetics and human bodily processes, etc.

Despite them occurring in very small concentrations in the indoor climate, research has shown that these substances probably play a major role in people's perception of the air quality, and they have an impact on our mental well-being.

As VOC and CO<sub>2</sub> concentrations do not necessarily occur together, it makes sense to have a separate measurement of VOCs that demand controls the ventilation based on the VOC concentration, or better still, based on the VOC concentration and the CO<sub>2</sub> concentration at the same time.

The benefit for occupants of the rooms will be that the air replacement is controlled on the basis of several relevant parameters.

The VOC sensor is available either as a stand-alone sensor or incorporated with Airmaster's existing CO<sub>2</sub> sensor. If incorporated, both sensors will operate in parallel, with the most critical signal determining the air replacement.

The demand control emits a modulating operating signal which ensures that only the required amount of air is supplied to the room, thus reducing the energy consumption for ventilation.





Airmaster will be supplying demand control with a modulating VOC sensor suitable for ALL Airmaster units from Q3 2020.

**Display of CO<sub>2</sub> and VOC concentrations**

The CO<sub>2</sub> concentration is already displayed in Airlinq Online. This is being expanded to include a display of the VOC concentration. Depending on whether you wish to demand control according to the CO<sub>2</sub> concentration or the VOC concentration, you can simply use one or both displays.

The cooled air is fed into the air handling unit and the supply air temperature is thus kept to the desired level.

**Scales and interpretation:**

CO <sub>2</sub>		TVOC		Colours	Interpretation
Limits, ppm		Limits, ppb (parts per billion)			
From	To	From	To		
400	900	0	65	Dark green 	“really good”
900	1200	65	220	Light green 	“good”
1200	2000	220	660	Yellow 	“fair”
2000	5000	660	2200	Orange 	“poor”
5000		2200		Red 	“warning”

**Example of measurement:**

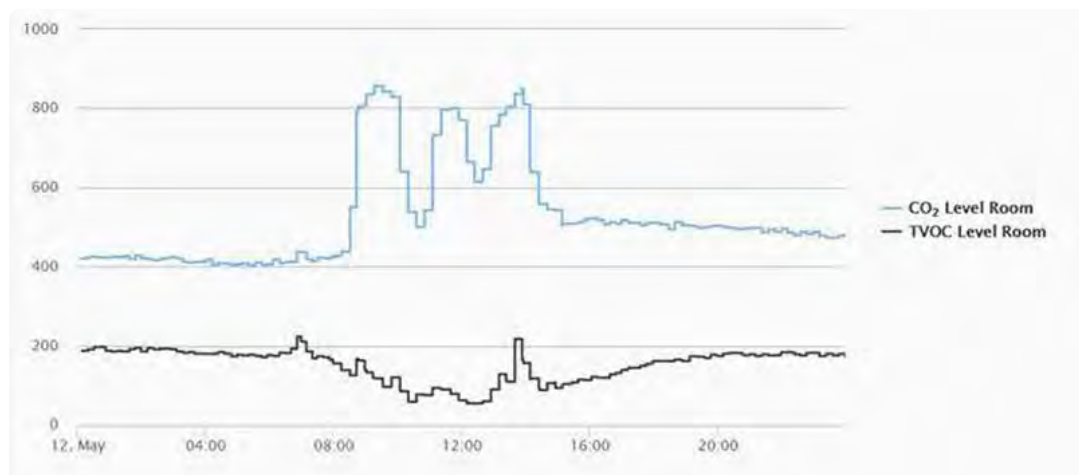





### CONTROL VIA MOTIONSENSOR (PIR)

The air handling unit is set to start/stop via a signal from a motion sensor. The motion sensor registers motion within its detection field and sends a signal to the unit to start. The unit will start in normal operation with the programmed airflow and inlet temperature.

When the signal ceases, the unit will stop after the preprogrammed afterrun time. A motion sensor is often used to switch the unit from basic ventilation to normal operation when anyone enters the detection field.



**A MOTION SENSOR** wall hung or built in. Ensures as little energy consumption as possible, as ventilation does not start until movement is detected in the room.

# CONTROL PROCESSES WITH HYGROSTAT



## **HUMIDITY CONTROL**

### **ADAPTIVE ON-DEMAND CONTROL**

Airmaster's new AM 300 ventilation unit can be fitted with two built-in humidity sensors and extended programming.

Integrated humidity and temperature sensors on supply and extract make exact calculation of absolute air humidity possible.

### **AUTOMATIC ADAPTATION TO WATHER CONDITIONS**

The adaptive humidity control automatically prevents the air drying out in the winter and reduces humidity in the summer. This effective, energy-saving form of operation creates a healthy environment and a healthy energy bill.

## **CONTROL BY A WALL-MOUNTED HYGROSTAT**

A hygrostat registers relative air humidity, and sends either a start or stop signal to the air handling unit.

Humidity in the air affects the length of hygroscopic man-made fibres. Depending on the humidity level, the fibres will activate a contact that triggers the signal.

When the relative air humidity goes over or under the level set, the hygrostat sends a start/stop signal to the air handling unit. Hygrostats are often used to switch a unit from basic ventilation to full operation when the relative humidity set is exceeded.



**HYGROSTAT** ensures that humidity is automatically kept down. Can be installed in the room or on the unit.

# PERFORMANCE TESTING OF VENTILATION UNITS

You are already operating a ventilation unit or have just had one installed, but is it operating as it should?

It is possible for you to performance test Airmaster ventilation units yourself, allowing you to check that that the unit is performing as it should at start-up, and that it continues to deliver the same quality.

You can choose to perform the test before the ventilation unit is started to remedy any installation errors. The test can also be performed as part of the annual service or when you change the filter. This will ensure optimal operation and energy consumption.

## What does the performance test show?

- Airflow (nominal air flow)
- Specific Fan Power (SFP)

## HOW TO PERFORM THE PERFORMANCE TEST

On all Airmaster ventilation units, you can access the “Airlinq Service Tool”. Under the “Performance Test” (from Airlinq Service Tool rev. 3.0.0.5) tab, you can perform the test on all newer Airmaster units yourself. You will be guided through the process step-by-step, in a simple and clear way, and a report will be generated at the end.

## WHY PERFORMANCE TEST?

Airmaster has developed this function in the “Airlinq Service Tool” based on Danish legal requirements, but it does not make the functionality less relevant in other countries. The reason for the requirement is a history of construction projects that have all too often been handed over with faulty technical installations. This has often resulted in higher energy consumption and poorer indoor climate than expected. Similar issues are also experienced in markets outside Denmark. Performance testing your Airmaster ventilation unit ensures optimal performance.

Airmaster recommends testing the units after installation, before using them. This can help prevent faults, a poorer indoor climate and unforeseen energy consumption as a result of this. We also recommend continuously utilising the functionality provided in our standard software to ensure optimal operation and energy consumption.



Airlinq Service Tool:  
<http://www.airlinq.eu/servicetool>

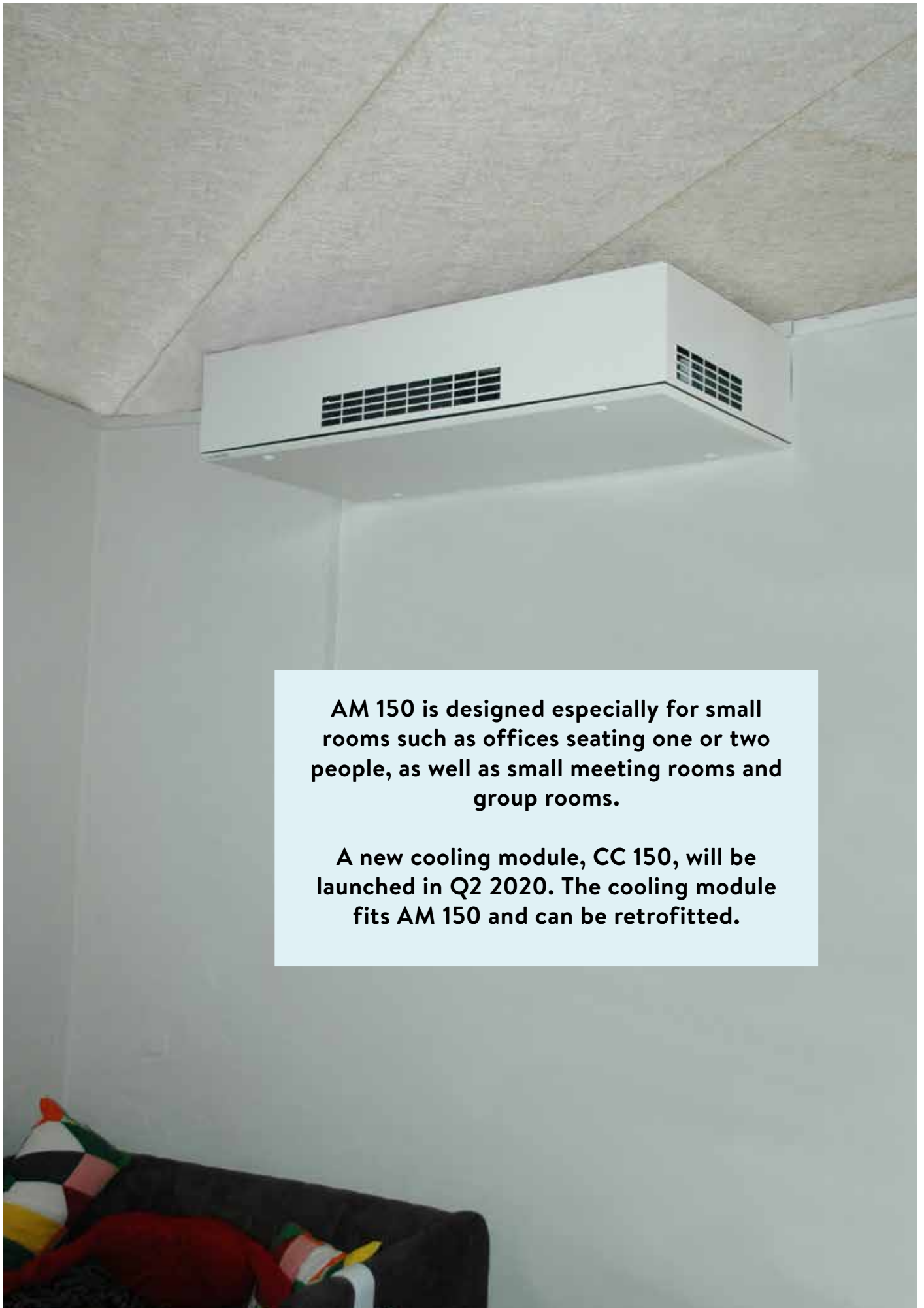

**AM 150 is designed especially for small rooms such as offices seating one or two people, as well as small meeting rooms and group rooms.**

**A new cooling module, CC 150, will be launched in Q2 2020. The cooling module fits AM 150 and can be retrofitted.**

# AM 150

AM 150 is a horizontal model and supply and exhaust pass horizontally out of the unit and through an outer wall.

AM 150 is particularly suited for one to two-person offices and small meeting rooms at companies, schools and institutions. Essentially, small rooms where there is a need for a pleasant indoor climate for comfort and well-being.

With options such as motion sensors and CO<sub>2</sub> sensors, ventilation can be controlled based on the number of people in a room at a given time. Furthermore, the fully automatic control can be combined with Airmaster Airlinq® Online.



TECHNICAL DATA	FILTER CLASS	30 dB(A)	35 dB(A)	BOOST
Maximum capacity	ePM <sub>10</sub> 75%	115 m <sup>3</sup> /h	147 m <sup>3</sup> /h	216 m <sup>3</sup> /h
	ePM <sub>1</sub> 55%	90 m <sup>3</sup> /h	126 m <sup>3</sup> /h	197 m <sup>3</sup> /h
	ePM <sub>1</sub> 80%	85 m <sup>3</sup> /h	115 m <sup>3</sup> /h	180 m <sup>3</sup> /h
Throw length (0.2 m/s)	ePM <sub>10</sub> 75%	2,6 m at 115 m <sup>3</sup> /h	3,4 m at 147 m <sup>3</sup> /h	-
	ePM <sub>1</sub> 55%	2,1 m at 90 m <sup>3</sup> /h	2,8 m at 126 m <sup>3</sup> /h	-
	ePM <sub>1</sub> 80%	1,9 m at 85 m <sup>3</sup> /h	2,6 m at 115 m <sup>3</sup> /h	-
Nominal current*		0,2 A	0,3 A	1 A
Nominal power consumption*		21 W	38 W	96 W
Electrical connection		1 x 230 V + N + PE / 50 Hz		
Duct connections		Ø125 mm		
Weight		47 kg		
Counterflow heat exchanger		PET		
Supply air filter		ePM <sub>10</sub> 75%, ePM <sub>1</sub> 55% or ePM <sub>1</sub> 80%		
Extract air filter		ePM <sub>10</sub> 75%		
Colour, panel		RAL 9010 (white)		
Power cable		3 x 0,75 mm <sup>2</sup>		
Recommended fuse		10 A		
Leakage current		≤ 0,5 mA		
Energy class (SEC-class)		A		
Air leakage classification		Class L1 cf. EN 1886:2007		
		Class A1 cf. EN 13141-7:2010		
Dimensions (WxHxD)		1170 x 261 x 572 mm		

\* At filter class, supply air/extract air: ePM<sub>10</sub> 75% / ePM<sub>10</sub> 75%

ELECTRIC HEATING SURFACE	
Heat output	600 W
Thermal circuit breaker, aut. reset	75°C
Thermal circuit breaker, man. reset	90°C

STANDARD AND OPTIONS	AM 150 H
Bypass	X
Electric heating surface/VPH	●
CO <sub>2</sub> sensor (built-in)	●
PIR/motion sensor (built-in)	●
Condensate pump	●
Motor driven exhaust air damper	X
Motor driven supply air damper	X
Counterflow heat exchanger (PET)	X
Energy meter	●
Wall / Ceiling frame	●

X: standard ●: option

# AM 150

CAPACITY with ePM<sub>10</sub> 75% + ePM<sub>10</sub> 75% filter

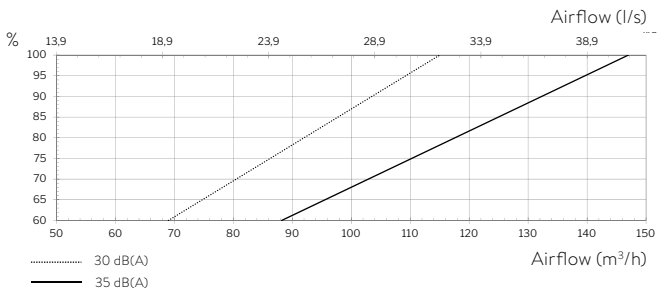

SFP<sup>1</sup>

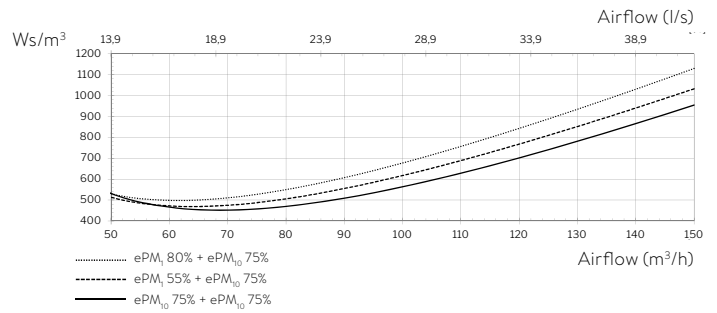

CAPACITY with ePM<sub>1</sub> 55% + ePM<sub>10</sub> 75% filter

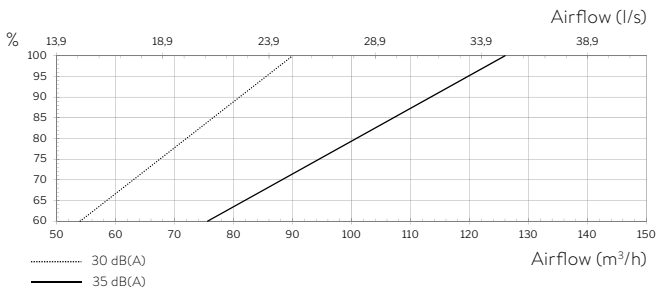

POWER CONSUMPTION<sup>1</sup>

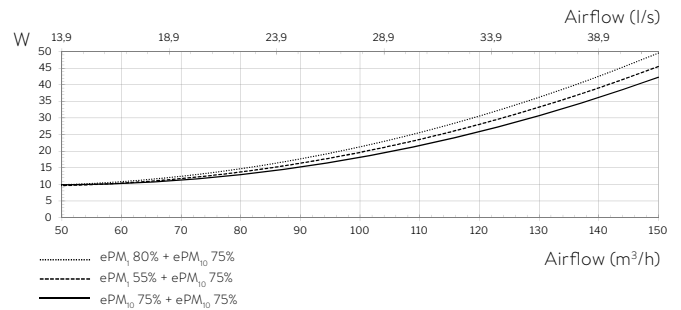

CAPACITY with ePM<sub>1</sub> 80% + ePM<sub>10</sub> 75% filter

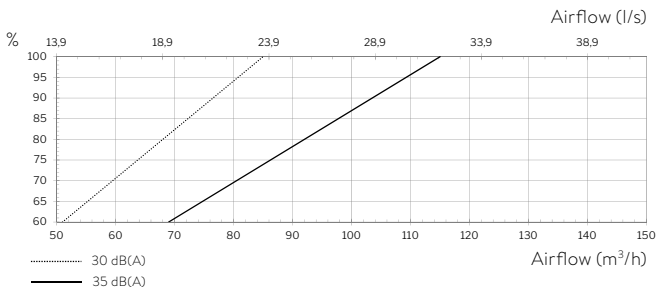

SOUND PRESSURE<sup>2</sup>

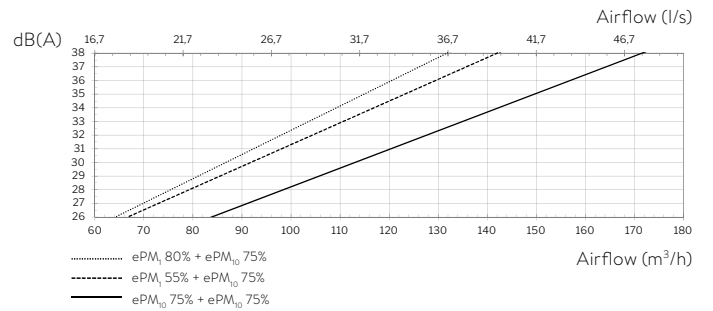

TEMPERATURE EFFICIENCY, ACC. TO EN 308:1997

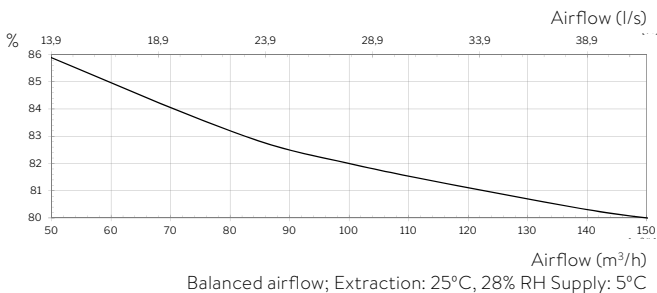

<sup>1</sup> Measurements are taken at normal operation in a standard installation situation with Airmaster's recommended Ø125 mm wall grille.

<sup>2</sup> Sound pressure level  $L_{p,eq}$  is measured at 1.2 m height with 1 m horizontal distance from the air handling unit in a 200 m<sup>3</sup> room with a reverberation time of  $T = 0.6$  s or equivalent to a room sound attenuation of 7.5 dB. In smaller rooms, e.g. 40 m<sup>3</sup>, 2 dB of sound pressure must be added.



# AM 150

SFP with ePM<sub>10</sub> 75% supply air filter and ePM<sub>10</sub> 75% extract air filter:<sup>1</sup>

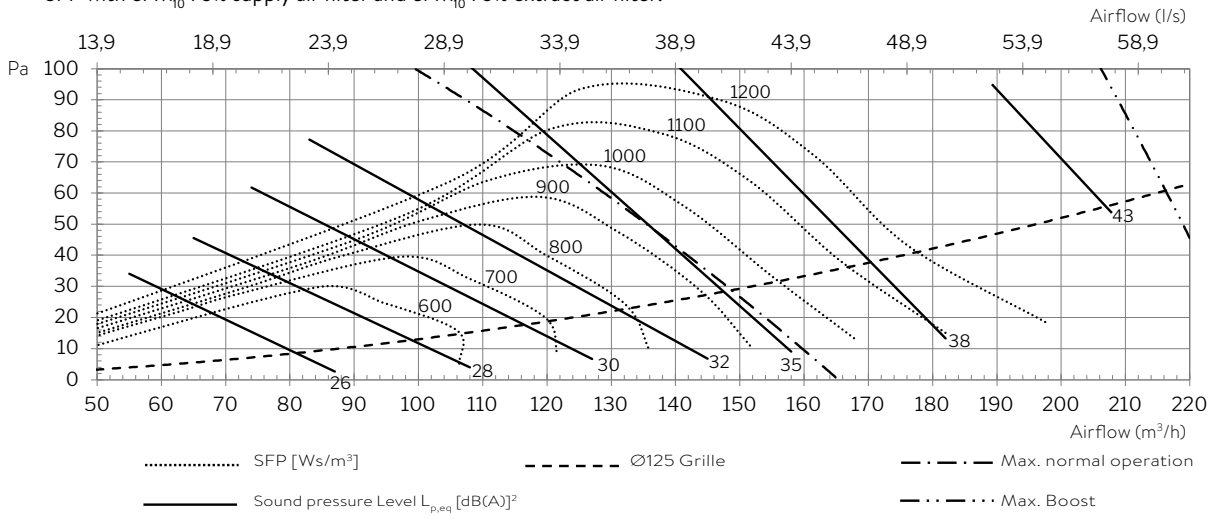

SFP with ePM<sub>1</sub> 55% supply air filter and ePM<sub>10</sub> 75% extract air filter:<sup>1</sup>

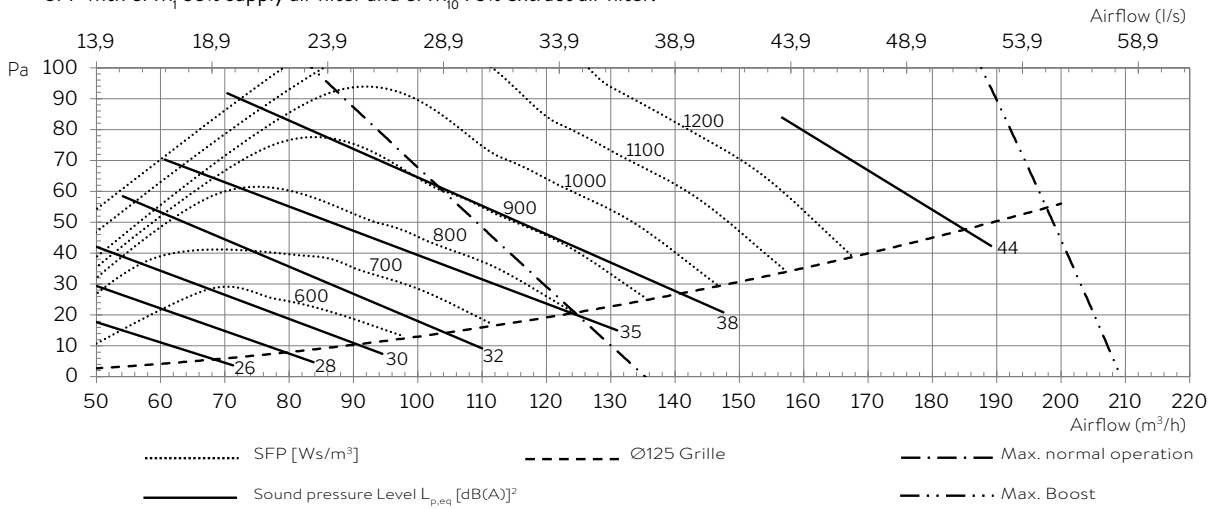

SFP with ePM<sub>1</sub> 80% supply air filter and ePM<sub>10</sub> 75% extract air filter:<sup>1</sup>

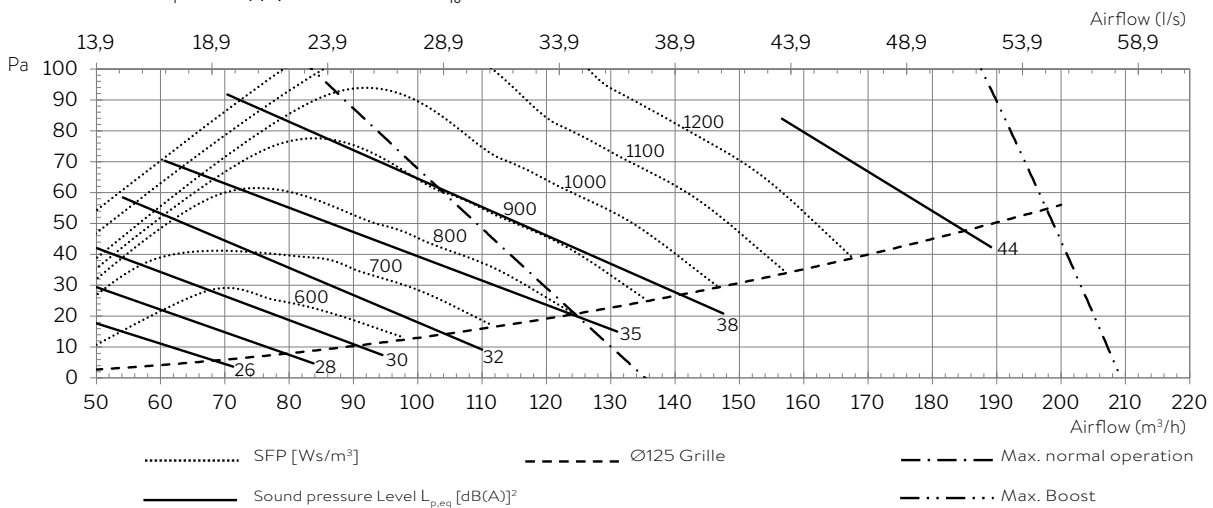

<sup>1</sup> Measurements are carried out in a 200 m³ room with 7.5 dB room sound attenuation in a standard installation situation.

<sup>2</sup> Sound pressure level  $L_{p,eq}$  is measured at 1.2 m height with 1 m horizontal distance from the air handling unit.

# AM 150

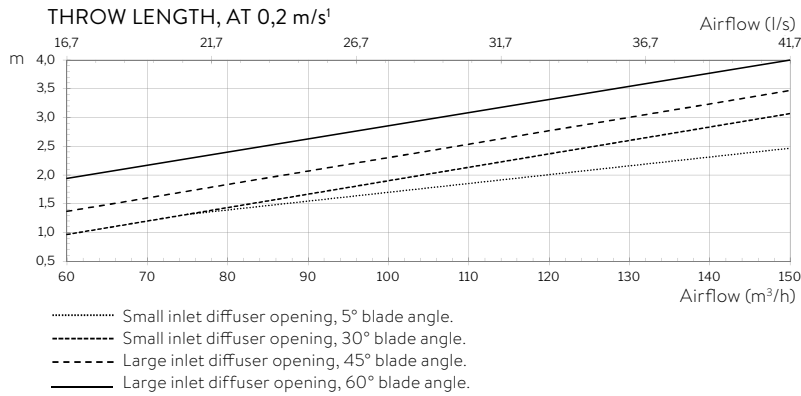

<sup>1</sup> The throw length is measured with 2°C subcooled inlet.

Small and large inlet diffuser area:

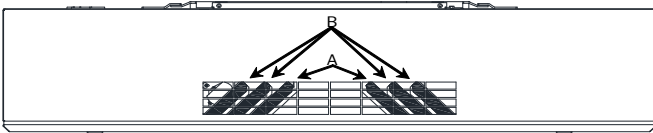

Small inlet diffuser area:  
A is closed, B is open with X degree blade angle.

Large inlet diffuser area:  
A and B are open with X degree blade angle.

Default delivery state:  
Small inlet diffuser area, 45 degree blade angle.

THROW, SIDE VIEW

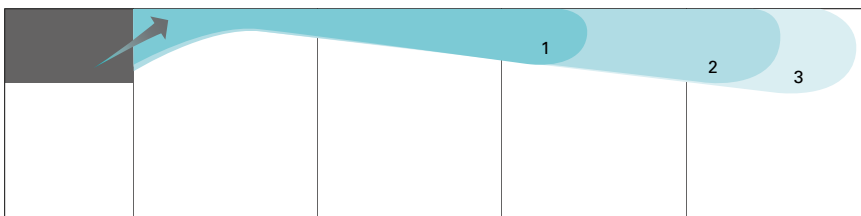

The ventilation unit diffuses the supply air to varying degrees depending on the slat settings.

This is shown in the illustrations, which indicate the diffusion pattern and throw at the different slat settings.

The airflow also influences the throw.

THROW, TOP VIEW

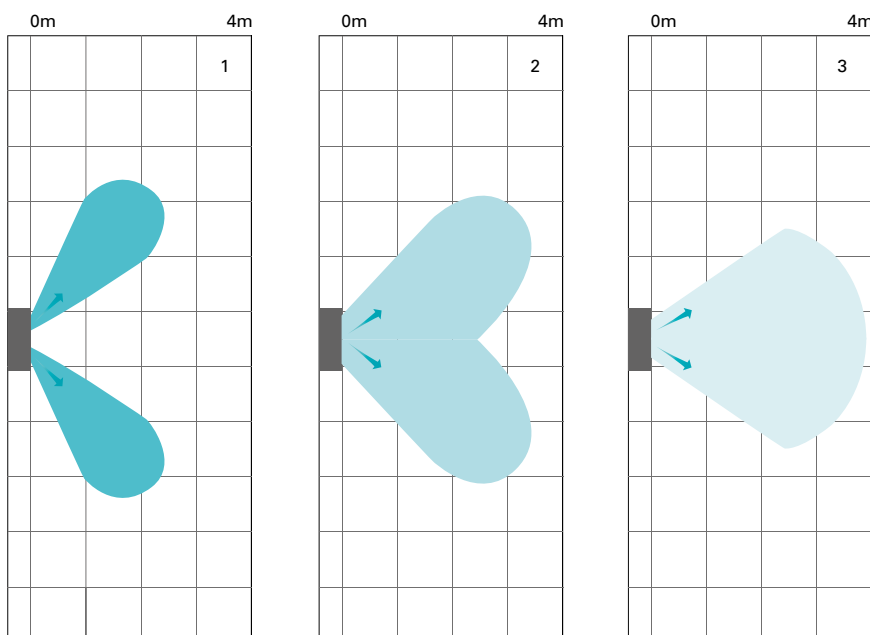

Throw length at 0,2 m/s. The supply pattern is shown in different settings at 147 m³/h.

1. Throw length with 60° blade angle.
2. Throw length with 45° blade angle. (Small inlet diffuser)
3. Throw length with 30° blade angle.

Regarding adjustment of blade angle, see operator's manual.

# AM 150

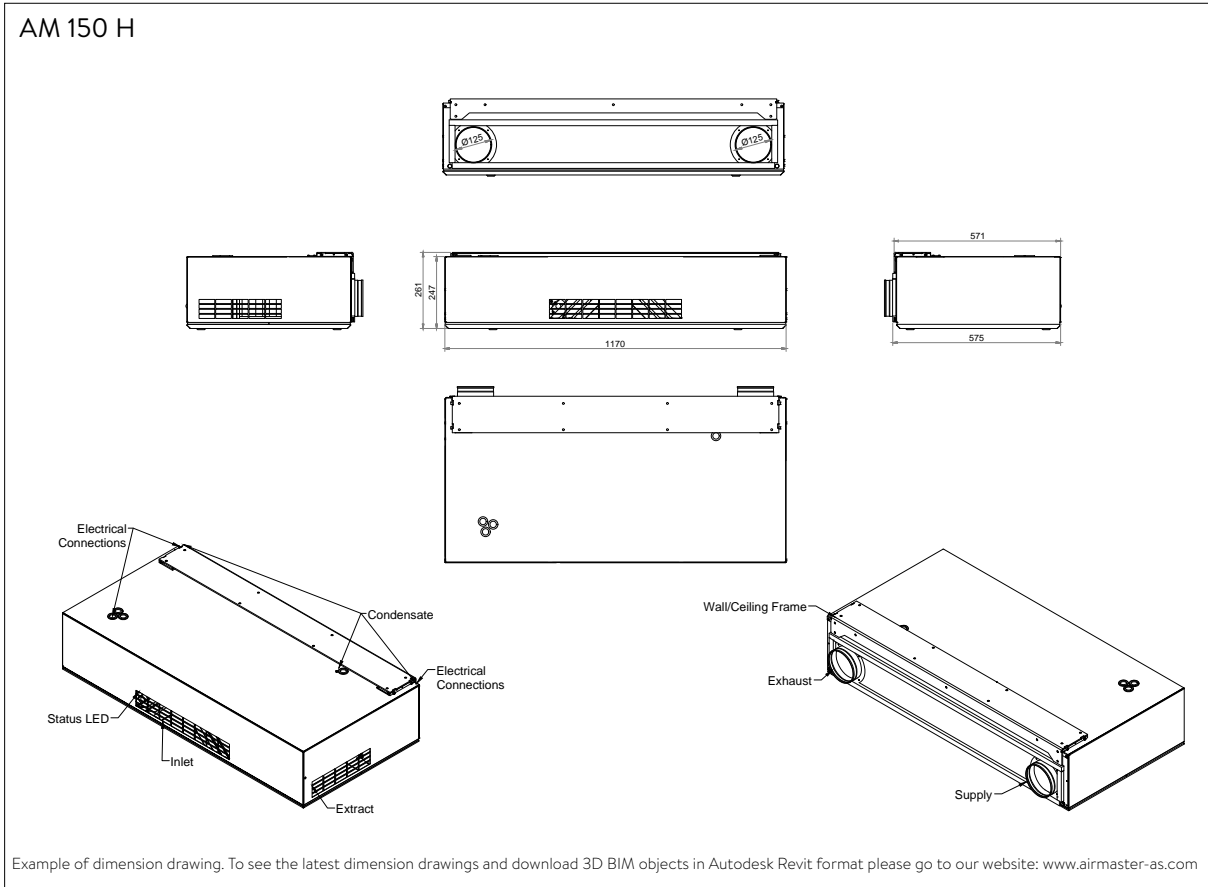

## SCHEMATIC SKETCH

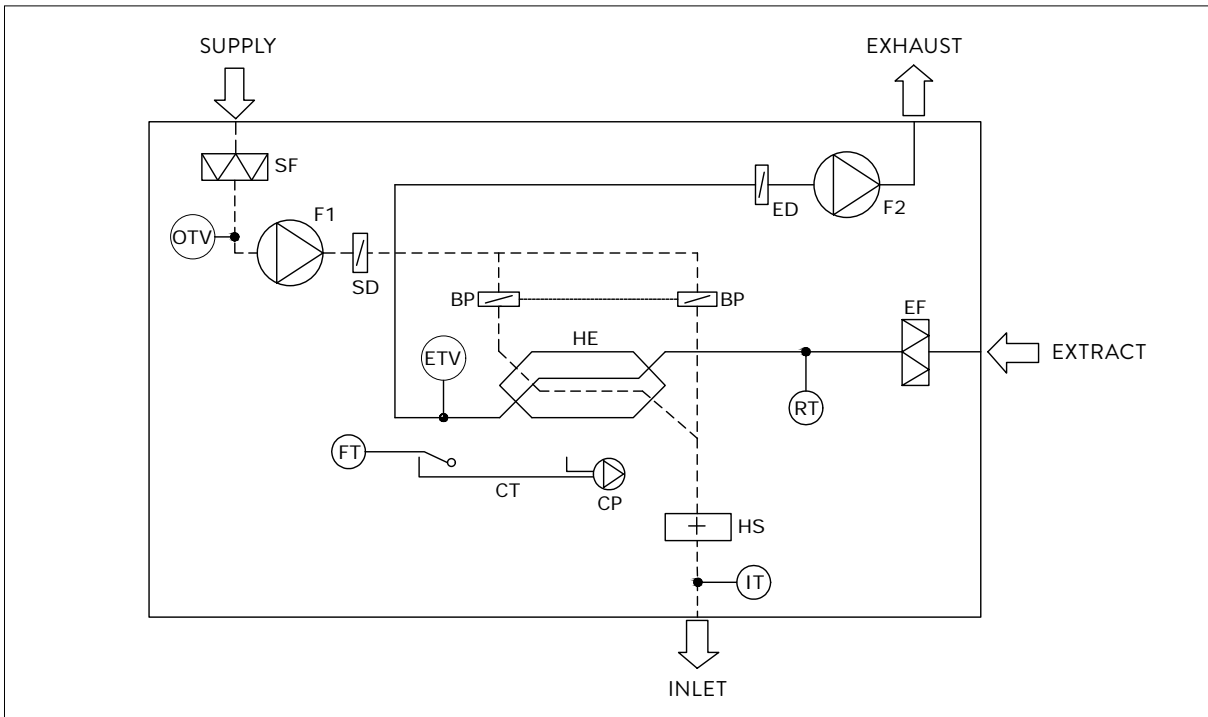

### NAME OF COMPONENT

BP	Bypass damper (motor driven)	FT	Float	OTV	Outside temperature sensor
CP	Condensate pump (option)	F1	Supply air fan	RT	Room temperature sensor
CT	Condensate tray	F2	Extract air fan	SD	Supply air damper (motor driven)
ED	Exhaust air damper (motor driven)	HE	Counterflow heat exchanger	SF	Supply air filter
EF	Extract air filter	HS	Heating surface (option)		
ETV	Exhaust temperature sensor	IT	Inlet temperature sensor		

**An Airmaster AM 300 ventilation unit promotes well-being in small rooms such as offices and meeting rooms.**





Airmaster presents the  
new AM 300.  
A long list of improvements  
but basically the same



The basic principles of the AM 300 are a continuation of Airmaster's high standard for achieving a good indoor climate with the lowest possible energy consumption and the best cost of life. Low energy consumption and a high level of heat recovery based on the principles of mechanically balanced ventilation therefore still form the backbone of the AM 300.

The current model of the AM 300, which has been around since 2007, has sold extensively throughout most of Europe, with some 12,000 AM 300 units supplied over the years.

The new AM 300 must therefore continue the success story, and it is with no small amount of pride that we now present a new generation of AM 300. The new AM 300 is also the first of Airmaster's new model range to be launched in the coming years. A model range that has undergone a lengthy development process and which features a host of new and improved initiatives, which we will present below.

**No attention to detail has been spared.**

The new AM 300 is a decentralised ventilation unit of exceptional quality, offering a high level of flexibility and carefully considered, user-friendly technical details. Low energy consumption and environmental sustainability have also been in focus.

**The new AM 300 is a continuation of the existing AM 300.**

All the best features of the existing model have been preserved: EC motors, efficient counterflow heat exchanger, automation, to name but a few. However, the AM 300 has been updated and improved on a long list of points, so it is safe for us to say that the product takes decentralised ventilation soundly into the next phase of the concept – decentralised ventilation for comfort use.

# FULL FLEXIBILITY ON THE FAÇADE AND INSIDE THE BUILDING



## ON THE FAÇADE

- Use and installation of the new AM 300 are extremely flexible
- The supply and exhaust can be positioned in the back, the top or the side of the unit.
- Ducted supply air and ducted exhaust air can be supplied.

A neat, uniform look can be achieved externally with the side supply and exhaust, regardless of the location of the unit. Inside, it can be made to fit around windows and beams, allowing you to take the design and layout of the rooms into account.

## AM 300 VERSION OVERVIEW

Exhaust/supply position

- Rear (H: **H**orizontal)
- In the top (V: **V**ertical)
- In the side (S: **S**ide)
- Combinations

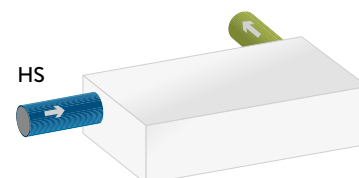
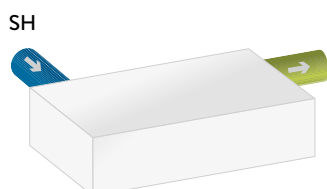
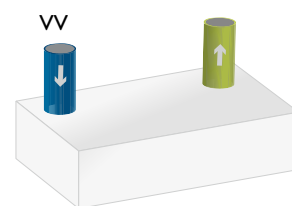
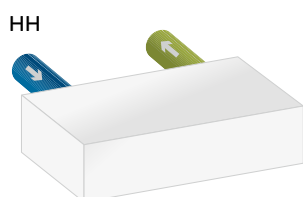
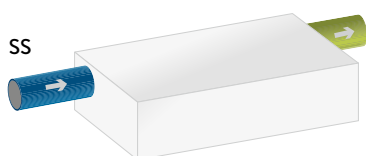

Inlet / extract position

- Bottom (B)
- Ducted inlet (DI)
- Ducted extract (DE)

## INSIDE THE BUILDING

The inlet grill is now always positioned at the bottom of the front of the unit. A new inlet system, where the upward inlet ensures proper air diffusion, provides draught-free ventilation. The same high quality of air distribution is achieved in the room whether the new AM 300 is installed under the ceiling or partially integrated into it. Under normal circumstances, the unit can be lowered up to 50 cm from the ceiling and continue to maintain a draught-free inlet.

Model variants inlet/extract:



BB: Standard inlet/extract

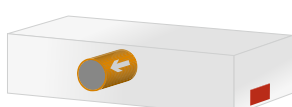

DIB: Ducted inlet/standard extract



BDE: Standard inlet/ducted extract

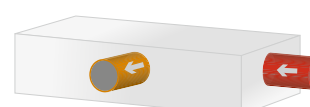

DIDE: Ducted inlet/ducted extract

Can be combined with all variants of supply/exhaust.



The option of ducted inlet and ducted extract offered by the new AM 300 make for great flexibility when it comes to installation.

For example:

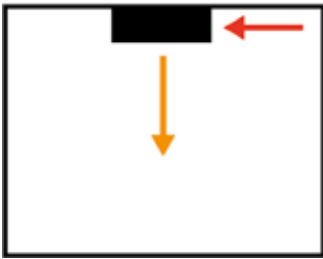

In a single room with standard inlet/extract.

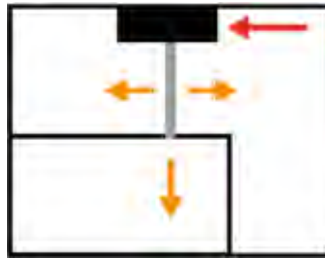

Where supply to an adjoining room is desired.

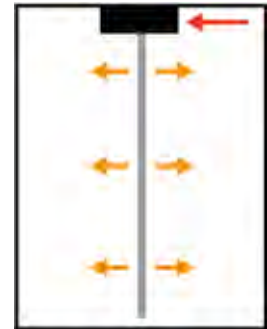

In a long room.

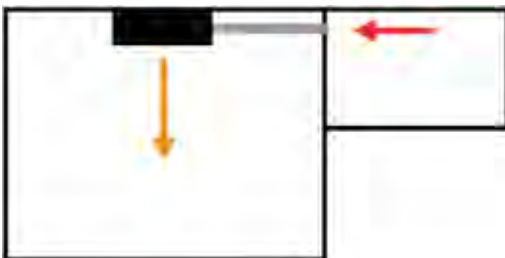

Where extract from an adjoining room is desired.

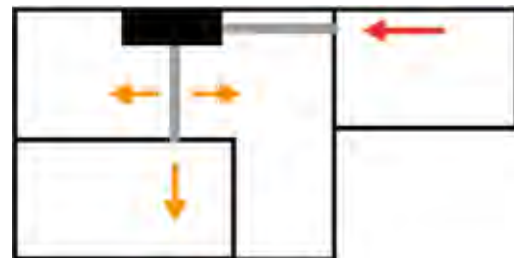

Where both extract and supply in adjoining rooms are desired.

It is also possible to install the ventilation unit fully or partially in the ceiling. All Airmaster ventilation units can be installed above a diffuse ceiling, leaving only the base plate visible. The air is blown in above the diffuse ceiling and seeps down through it. All that is needed for this is a separate extract fixture.



Installation with the ventilation unit under the ceiling.



Installation with the ventilation unit partially integrated in the ceiling.



Installation with a diffuse ceiling. The ventilation unit sits above the ceiling with the base plate accessible.

## FIRE AND SMOKE PROTECTION

If a ventilation unit serves more than one room, national fire and smoke protection regulations may apply.

## In relation to the previous generation, the new AM 300 has been particularly improved as follows:

### OPTION OF AN ePM<sub>1</sub> 80% FILTER

The new AM 300 is more compressive than its predecessor and can be supplied with an ePM<sub>1</sub> 80% filter on supply air. ePM<sub>1</sub> 80% corresponds to the earlier F9 classification, and is, for example, suitable for use in metropolitan areas where filtration of microparticles from traffic is desirable. For use in ODA 2 climate zones. We have also made it easier to insert/remove the filter when space under the unit is limited.



### ADJUSTABLE SUPPLY AIR SYSTEM

The new AM 300 is fitted with a manual version of Airmaster's adaptive supply air system. The diffusion and throw of the supply air can be set to adjust the unit to the conditions.

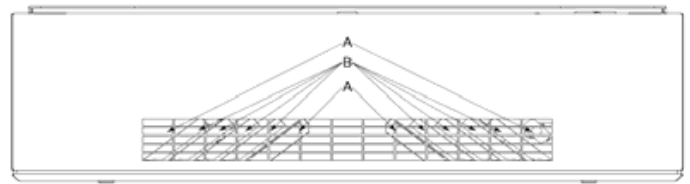
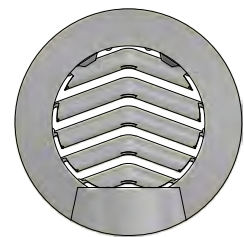

Illustration of the supply air system.

### SMALLER BUSHING IN WALL/ROOF - FROM Ø200 TO Ø160

In 2019, Airmaster launched the Boomerain façade grill (patent pending), which means that the dimension of wall bushings can be reduced.

The same applies to the new AM 300. The dimension has been reduced from Ø200 to Ø160. This makes drilling the hole cheaper and the façade grill less visible from the outside.



Façade grill - Airmaster Boomerain Ø160 is set for launch Q2 2020

- A service switch can be supplied as an option, so that units stop when the base plate is opened.
- Base plate with 4-link hinge, which makes for the safe, precise positioning of the base plate in relation to the cabinet. It also allows space for a door or window frame behind the base plate.
- Wiring and condensation drain hoses can be routed to either side of the unit.
- There is space for 40 mm condensation insulation and 13 mm plasterboard around pipes for supply air and extract air.

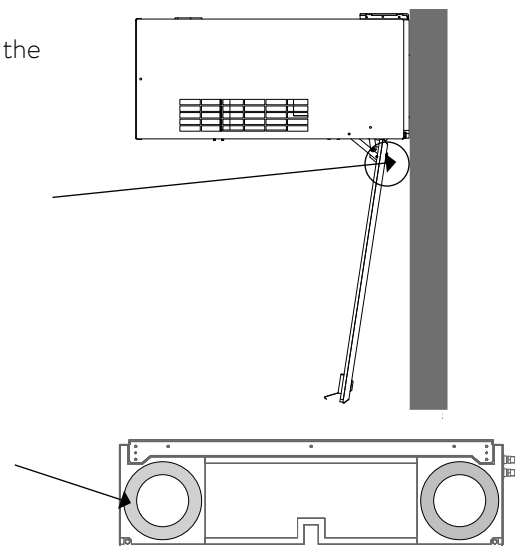

## ENVIRONMENTAL MEASURES

Recyclability has been in focus during the development of the new AM 300, and several measures have been taken in connection with the selection of components.

- As many components as possible can be separated and reused at the end of the unit's life.
- New wire bushings make it easier to remove electrical components from the unit.
- New production methods have been introduced which have, for example, reduced the use of adhesives by up to 90%.
- The insulation is free of pigments and made from recycled foam materials of 100% polyurethane granulate, which can be recycled.

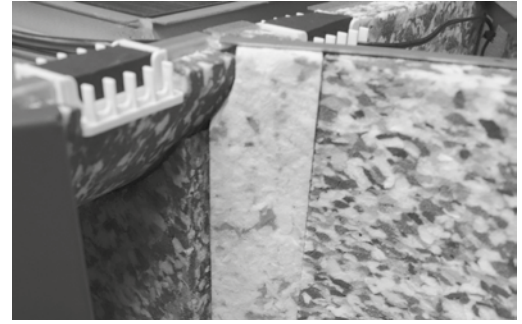

## FOCUS ON LOW NOISE

With the new AM 300, we have set ourselves the challenge of meeting the particularly stringent requirements for low-frequency noise that apply to school buildings in Sweden and Norway, among other places. We have risen to the challenge and believe that the improved low-frequency noise performance is of interest to all our customers. These requirements are simply formulated in Swedish law, in that the C-weighted sound level must not exceed the A-weighted sound level by more than 20 dB, so that at 30 dB(A), a maximum of 50 dB(C) may occur.

## FOCUS ON AIRTIGHTNESS AND MINIMAL LEAKAGE

Airtightness has been improved on the new AM 300 and complies with class L2, cf. EN 1886:2007, and class A1, cf. EN 13141-7:2010. Airtightness also applies to the newly developed shut-off dampers, which comply with class 3 for shut-off dampers, cf. EN 1751:2014.

## AM 300, POLAR EDITION AND ENTHALPY HEAT EXCHANGER

Airmaster is experiencing increasing demand for geographical regions where it can get extremely cold, with dimensioned outdoor temperatures down to -35°C. The new AM 300 is therefore being launched with two new initiatives.

- A "polar edition" can be supplied with an extra-large pre-heating element of 2500 W and operating parameters adapted to it.
- Instead of the normal heat exchanger, the AM 300 will be available from autumn 2020 with an enthalpy heat exchanger, which returns the moisture from the exhausted air. This solution is particularly suitable for use in cold areas, where it is desirable to retain the moisture inside the building. Further information to follow

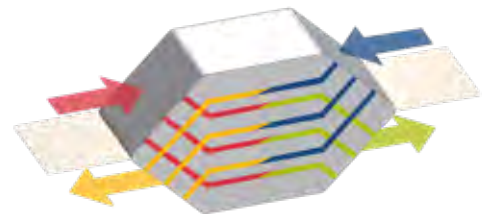

## LOW ENERGY CONSUMPTION – ECODESIGN CLASS A

The new AM 300 still has the low-energy EC motors and an efficient counterflow heat exchanger with an efficiency of approx. 85%. The unit uses very little energy to transport air, in fact, less than 2/3 of the Danish legal requirements – and complies with energy class A, cf. Ecodesign.

## HEATING ELEMENTS

Option to add heating elements.

- Electric preheating element (1000 W)
- Electric preheating element special "polar edition" (500 W)
- Electric heating element (1000W + 500W)
- A water heating element can be fitted as a heating element (1973 W)



# AM 300

TECHNICAL DATA	FILTERCLASS	30 dB(A)	35 dB(A)	BOOST
Maximum capacity *	ePM <sub>10</sub> 75%	210 m <sup>3</sup> /h	275 m <sup>3</sup> /h	315 m <sup>3</sup> /h
	ePM <sub>1</sub> 55%	205 m <sup>3</sup> /h	270 m <sup>3</sup> /h	315 m <sup>3</sup> /h
	ePM <sub>1</sub> 80%	180 m <sup>3</sup> /h	240 m <sup>3</sup> /h	305 m <sup>3</sup> /h
Throw length (0.2 m/s) **	ePM <sub>10</sub> 75%	4,25 m at 210 m <sup>3</sup> /h	6 m at 275 m <sup>3</sup> /h	7 m at 315 m <sup>3</sup> /h
	ePM <sub>1</sub> 55%	4,25 m at 205 m <sup>3</sup> /h	6 m at 270 m <sup>3</sup> /h	7 m at 315 m <sup>3</sup> /h
	ePM <sub>1</sub> 80%	3,5 m at 180 m <sup>3</sup> /h	5 m at 240 m <sup>3</sup> /h	6,75 m at 305 m <sup>3</sup> /h
Maximum ; nominal power consumption at 30dB(A) / 35 dB(A) / BOOST *	175 W / 55 W / 102 W / 123 W			
Maximum ; nominal current at 30dB(A) / 35 dB(A) / BOOST *	1,45 A / 0,45 A / 0,84 A / 1,01 A			
Supply voltage	1 x 230 V + N + PE / 50 Hz			
Duct connection	Ø160 mm			
Condensate pump (capacity/lifting height at 5 l/h)	10 l/h / 6 m			
Condensate drain hose int./ext. diameter	Ø4/6 mm			
Weight, standard air handling unit, complete	85 kg			
Weight, casing	70 kg			
Weight, service cover	15 kg			
Counterflow heat exchanger	Aluminium			
Supply air filter	ePM <sub>10</sub> 75%, ePM <sub>1</sub> 55% or ePM <sub>1</sub> 80%			
Extract air filter	ePM <sub>10</sub> 75%			
Colour, casing	RAL 9010 (white)			
Power factor	0,53			
Power cable	3 x 1,5 mm <sup>2</sup>			
Recommended fuse (standard / polar edition)	10 A / 16 A			
Maximum fuse	16 A			
Recommended residual current circuit breaker (RCCB)	Type A			
Leakage current AC/DC	≤ 0,7 mA / ≤ 0,005 mA			
IP code	10			
Energy class, cf. EU regulation no. 1254/2014	SEC class A			
Air leakage classification	Class L2 cf. EN1886:2007 Class A1 cf. EN13141-7:2010			
Air leakage classification, main damper	Class 3 cf. EN1751:2014			
Dimensions (WxHxD)	1180 x 344 x 705 mm			

\* All measurements were performed in normal operating mode in a standard installation for the filter class, supply/extract air: ePM10 75% / ePM10 75%, using the facade grills recommended by Airmaster: Airmaster Boomerain® Ø160, in a test room dimensioned 8.0 m x 10.0 m x 2.5 m with room attenuation of 7.5 dB.

\*\* The throw length is measured with a 2°C subcooled supply air at the standard setting of the inlet diffuser. The setting is adaptable.

ELECTRICAL HEATING SURFACES	PREHEATING SURFACE	COMFORT HEATING SURFACE
Heat output (standard / polar edition)	1000 W / 2500 W	500 W
Nominal strøm (standard / polar edition)	4,35 A / 10,87 A	2,17 A
Termostyring, manuel reset	120°C	120°C

WATER HEATING SURFACE	
Maximum operating temperature	90°C
Maximum operating pressure	10 bar
Nominal heat output ***	1973 W
Connection dimension	1/2" (DN 15)
Materials pipes/fins	copper/aluminium
Motorventil, åbne- og lukketid	60 s

\*\*\*Heat output for maximum capacity at 35 dB(A), delivery/return temperature 60/40°C and a liquid flow of 87 l/h.

# AM 300

## STANDARDS AND OPTIONS

Counterflow heat exchanger (alu)	X
Motor-driven bypass	X
Motor-driven supply air damper	X
Motor-driven extract air damper	X
Electric preheating surface	●
Electric preheating surface, polar edition	●
Electric comfort heating surface	●
Water heating surface	●
Condensate pump	●
Service power switch	●
Electronic humidity sensor (built-in)	●
PIR/motion sensor (built-in)	●
CO <sub>2</sub> sensor (built-in)	●
Energy meter	●
Supply air filter ePM <sub>10</sub> 75%	●
Supply air filter ePM <sub>1</sub> 55%	●
Supply air filter ePM <sub>1</sub> 80%	○
Extract air filter ePM <sub>10</sub> 75%	X
Wall/ceiling frame	●
Ceiling frame	●
LED (operating mode indicator)	X
Operating button	●
Control panel, Viva	●
Control panel, Orbit	●
Airmaster Airlinq® Online	●
Airlinq BMS	●
LON® Modul	●
KNX® Modul	●
MODBUS® RTURS485 Modul	●
BACnet® MS/TP Modul	●
BACnet® /IP Modul	●

X : standard    ● : optional    ○ : special item

# AM 300

## CAPACITY with ePM<sub>10</sub> 75% + ePM<sub>10</sub> 75% filter<sup>1</sup>

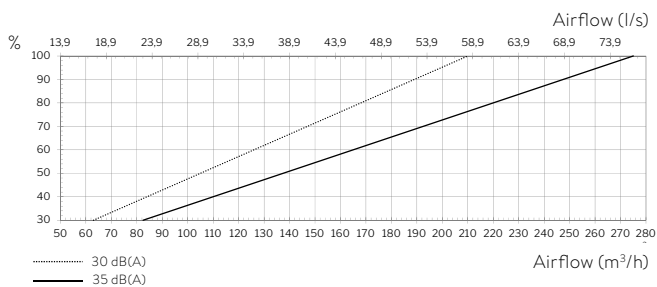

## SFP<sup>2</sup>

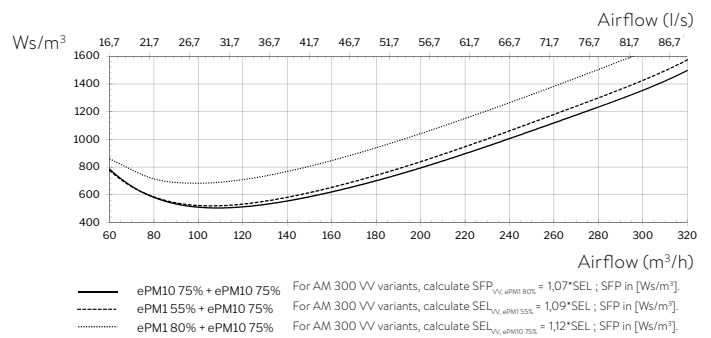

## CAPACITY with ePM<sub>1</sub> 55% + ePM<sub>10</sub> 75% filter<sup>1</sup>

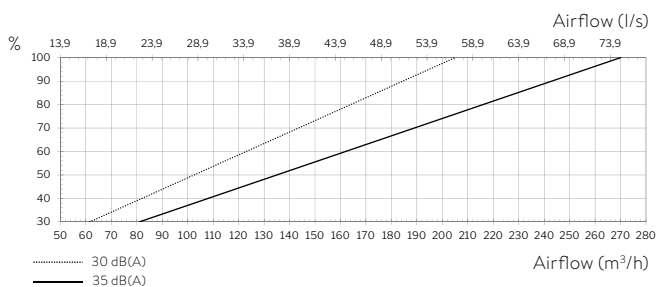

## POWER CONSUMPTION<sup>3</sup>

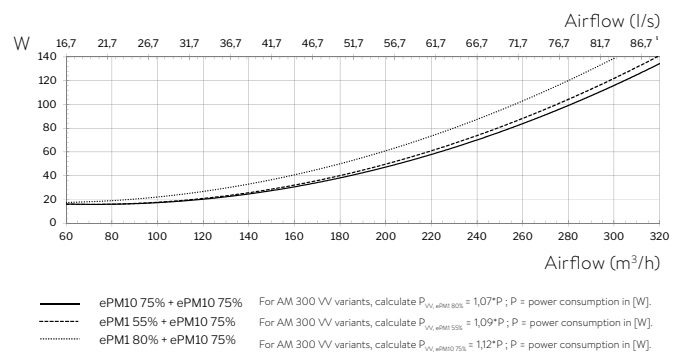

## CAPACITY with ePM<sub>1</sub> 80% + ePM<sub>10</sub> 75% filter<sup>1</sup>

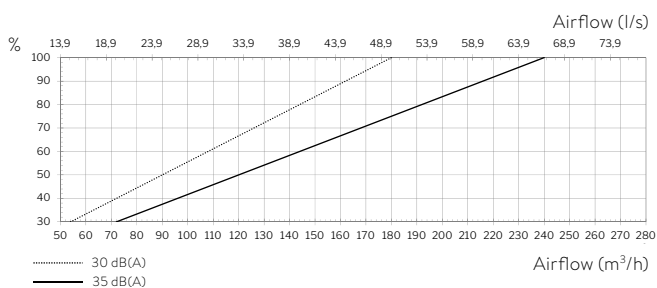

## SOUND PRESSURE<sup>4</sup>

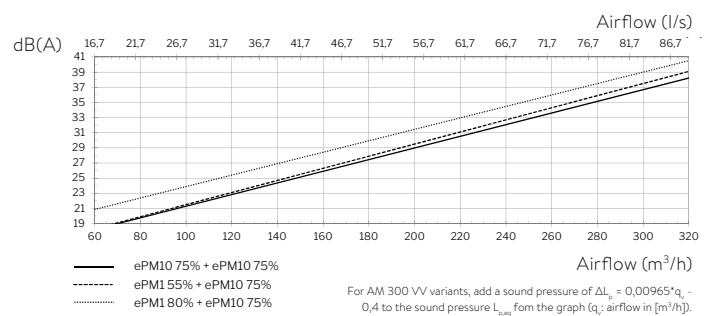

## TEMPERATURE EFFICIENCY, ACC. TO EN 380:1997 and EN 13141-7:2010

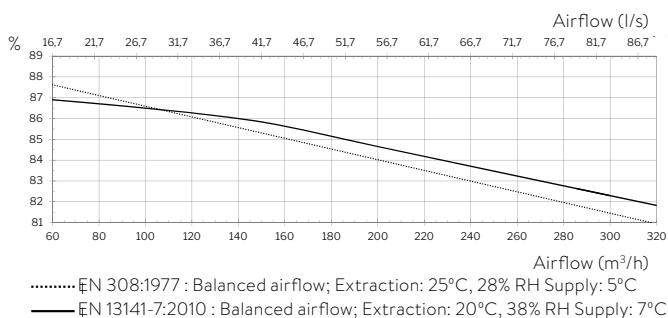

<sup>1</sup> AM 300 HH, SS and variants of this, including DI and DE variants.

Calculate airflow for AM 300 VV variants as follow:  $q_{VV, @30dB(A)} = 0,928 \cdot q_v$  eller  $q_{VV, @35dB(A)} = 0,928 \cdot q_v$ ;  $q_v$  = airflow from graph in [m³/h].

<sup>2</sup> AM 300 HH, SS and variants of this including DI and DE variants. The calculation of SFP includes the power consumption for operating fans but not for controls, display panels, etc.

<sup>3</sup> AM 300 HH, SS and variants of this, including DI and DE variants.

<sup>4</sup> The sound pressure level  $L_{p,eq}$  is measured at a height of 1.2 m at a horizontal distance of 1 m from the air handling unit.



# AM 300

SFP with ePM<sub>10</sub> 75% supply air filter and ePM<sub>10</sub> 75% extract air filter:

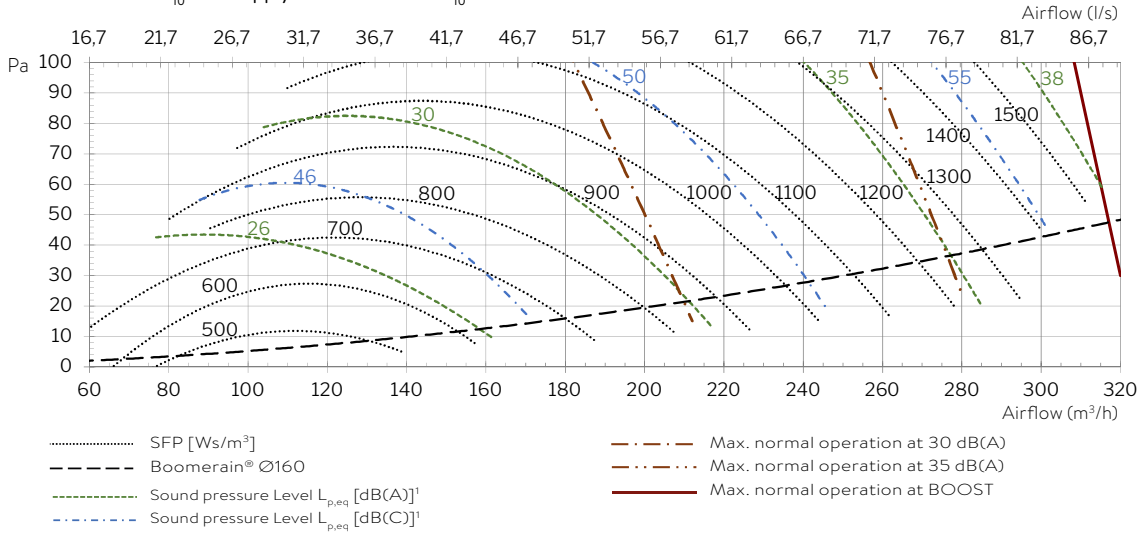

SFP with ePM<sub>1</sub> 55% supply air filter and ePM<sub>10</sub> 75% extract air filter:

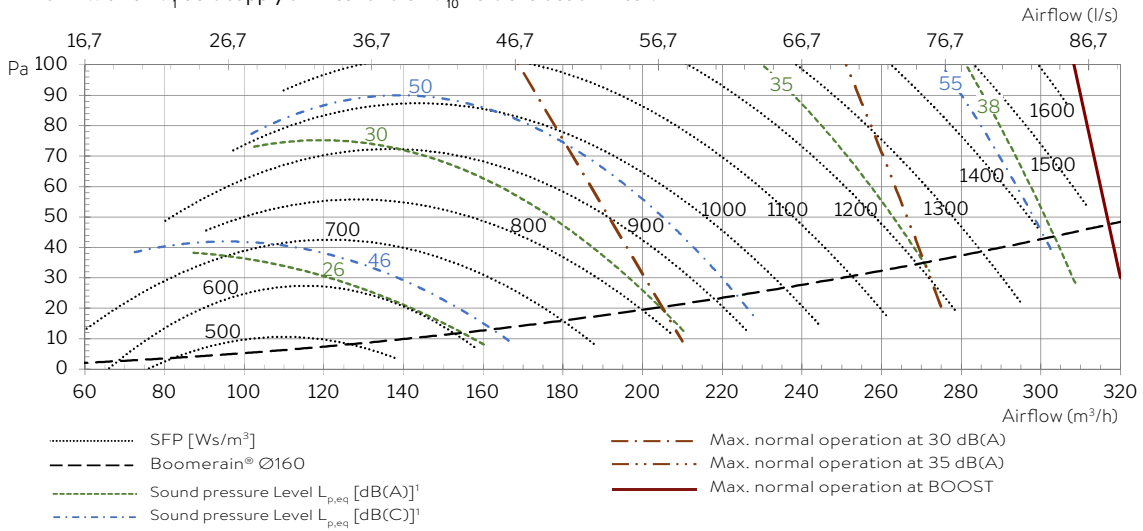

<sup>1</sup> The sound pressure level  $L_{p,eq}$  is measured at a height of 1.2 m at a horizontal distance of 1 m from the air handling unit.

# AM 300

## THROW LENGTH<sup>1</sup>

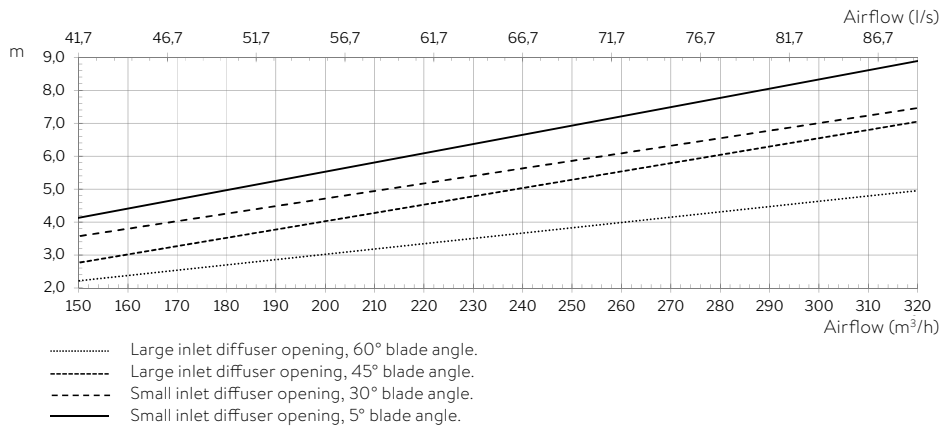

### Small and large inlet diffuser opening:

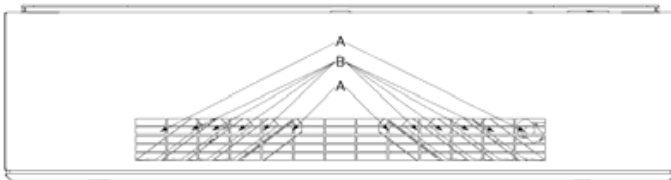

Large inlet diffuser opening:  
A is closed, B is open at  $x^\circ$ .

Large inlet diffuser opening:  
A and B are open at  $x^\circ$ .

Default delivery state:  
Large inlet diffuser opening, 45° blade angle.

### Throw length and dispersion, top view.

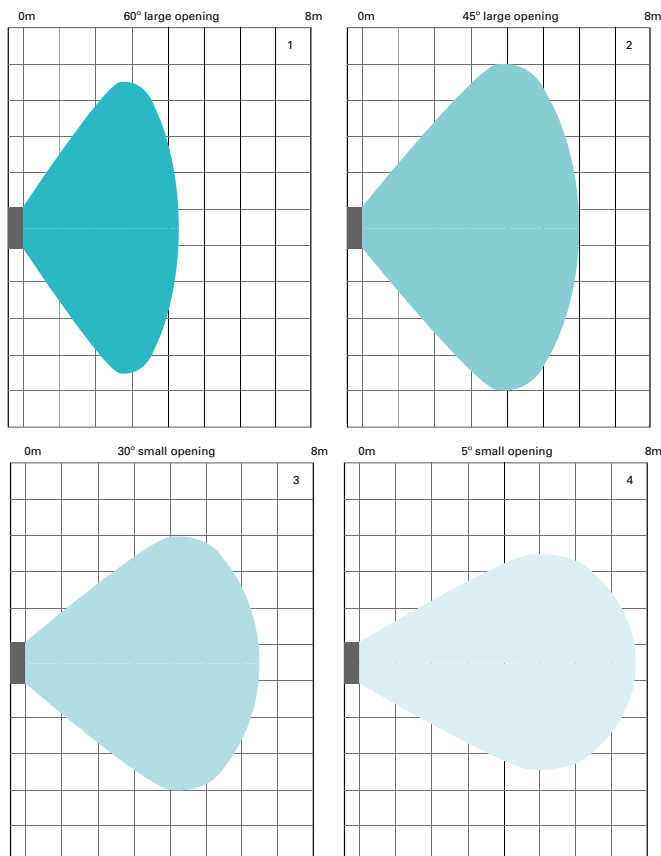

The air handling unit disperses inlet air depending on the blade angle settings.

The illustrations show the dispersion pattern and throw length for the various blade angle settings at an air flow of 275 m³/h:

1. Large inlet diffuser opening, 60° blade angle.
2. Large inlet diffuser opening, 45° blade angle.
3. Small inlet diffuser opening, 30° blade angle.
4. Small inlet diffuser opening, 5° blade angle.

Changing the air flow also affects the throw length.

### Throw length, side view.

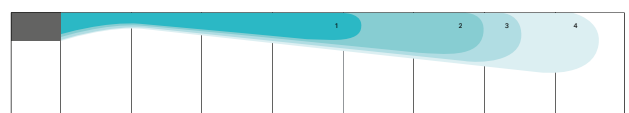

<sup>1</sup> The throw length is measured with a 2 °C subcooled inlet air supply.

# AM 300

## AM 300 HHBB

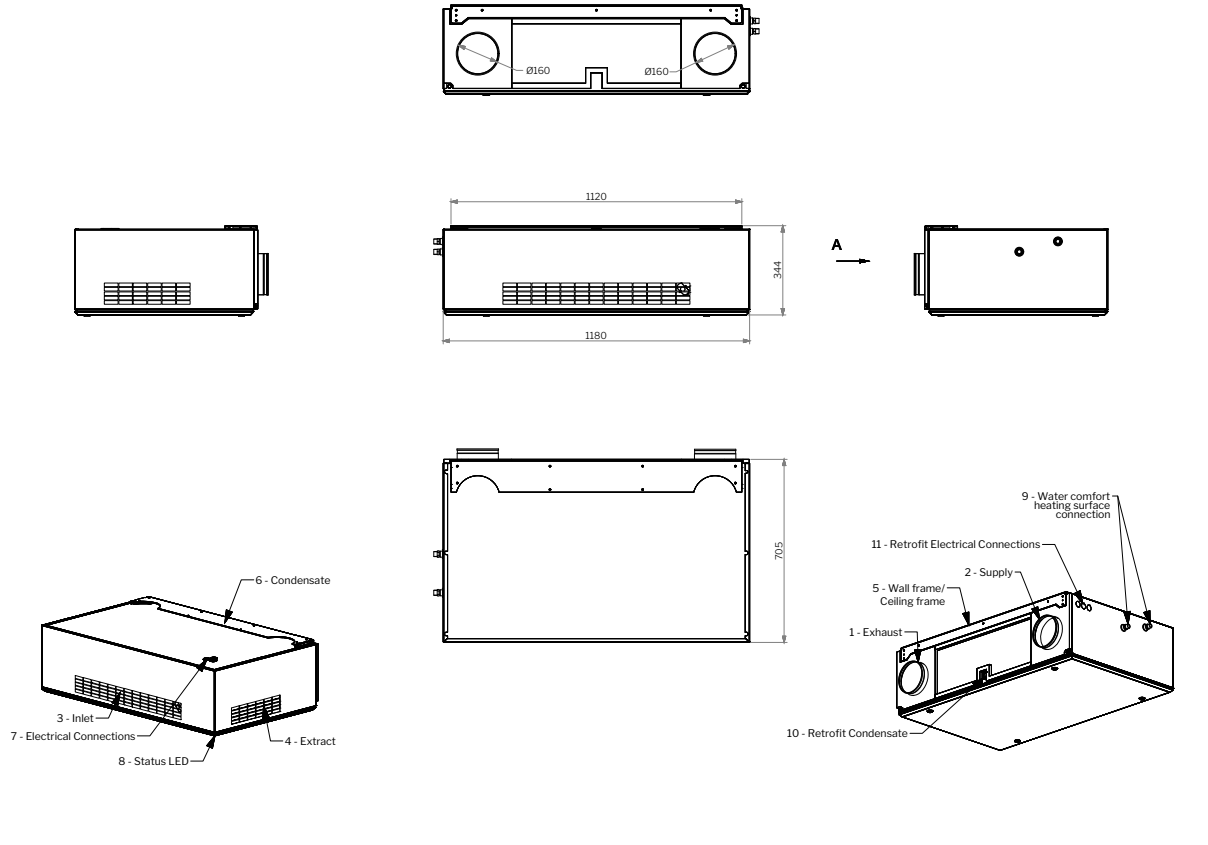

## AM 300 VVBB

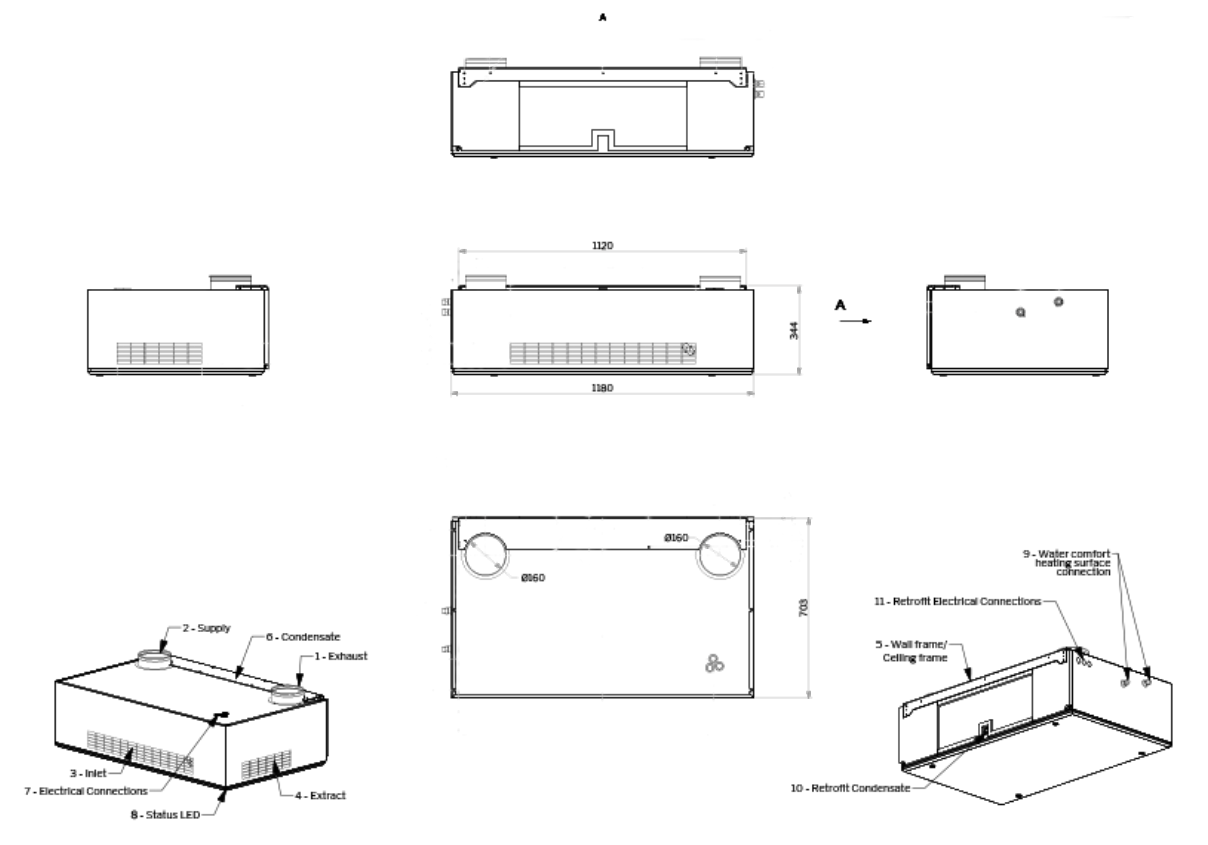

Example of dimension drawing. To see the latest dimension drawings and download 3D BIM objects in Autodesk Revit format please go to our website: [www.airmaster-as.com](http://www.airmaster-as.com)

# AM 300

## SCHEMATIC SKETCH

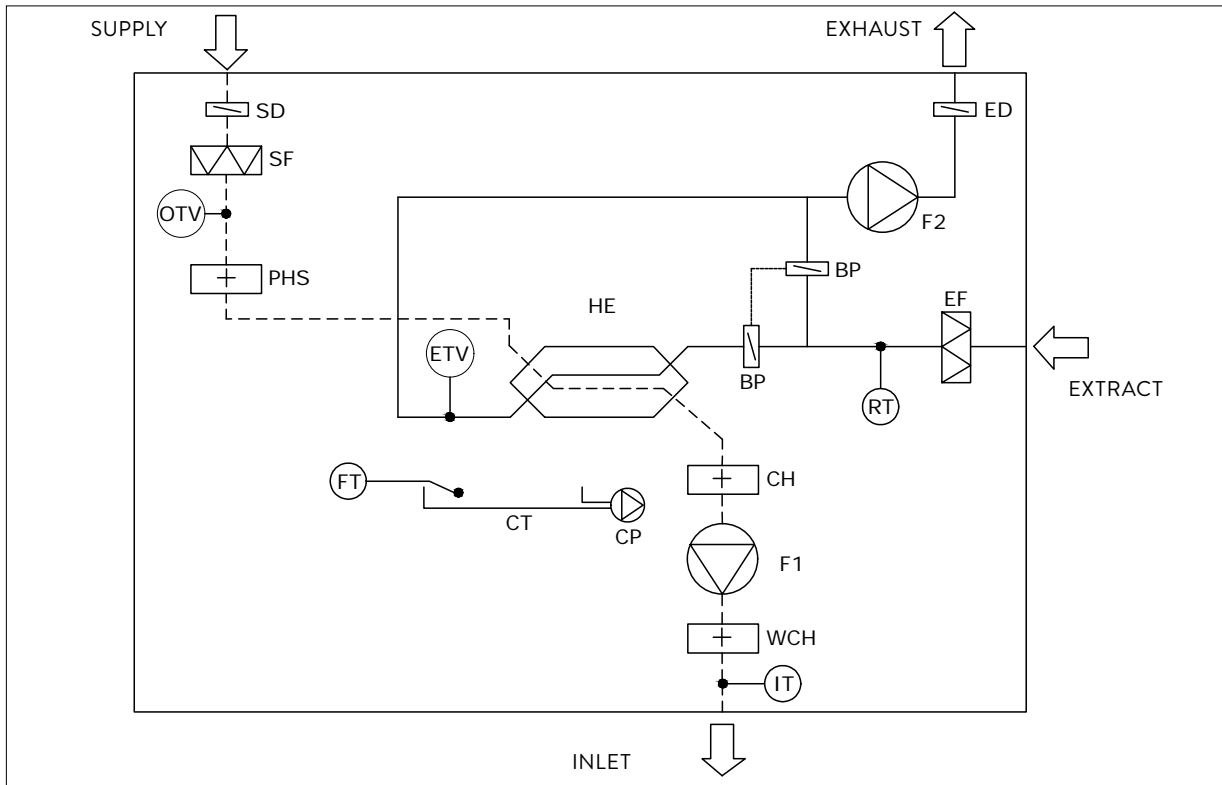

### NAME OF COMPONENT

BP	Bypass damper (motor-driven)	ETV	Exhaust temperature sensor, ventilation	IT	Inlet-air temperature sensor
CH	Electric comfort heating surface (option)	FT	Float	OTV	Supply air temperature sensor, ventilation
CP	Condensate pump (option)	F1	Supply air fan	PHS	Electric preheating surface (option)
CT	Condensate tray	F2	Extract air fan	RT	Room temperature sensor
ED	Exhaust air damper (motor-driven)	HE	Counterflow heat exchanger	SD	Supply air damper (motor-driven)
				SF	Supply air filter
				WCH	Water heating surface (option)



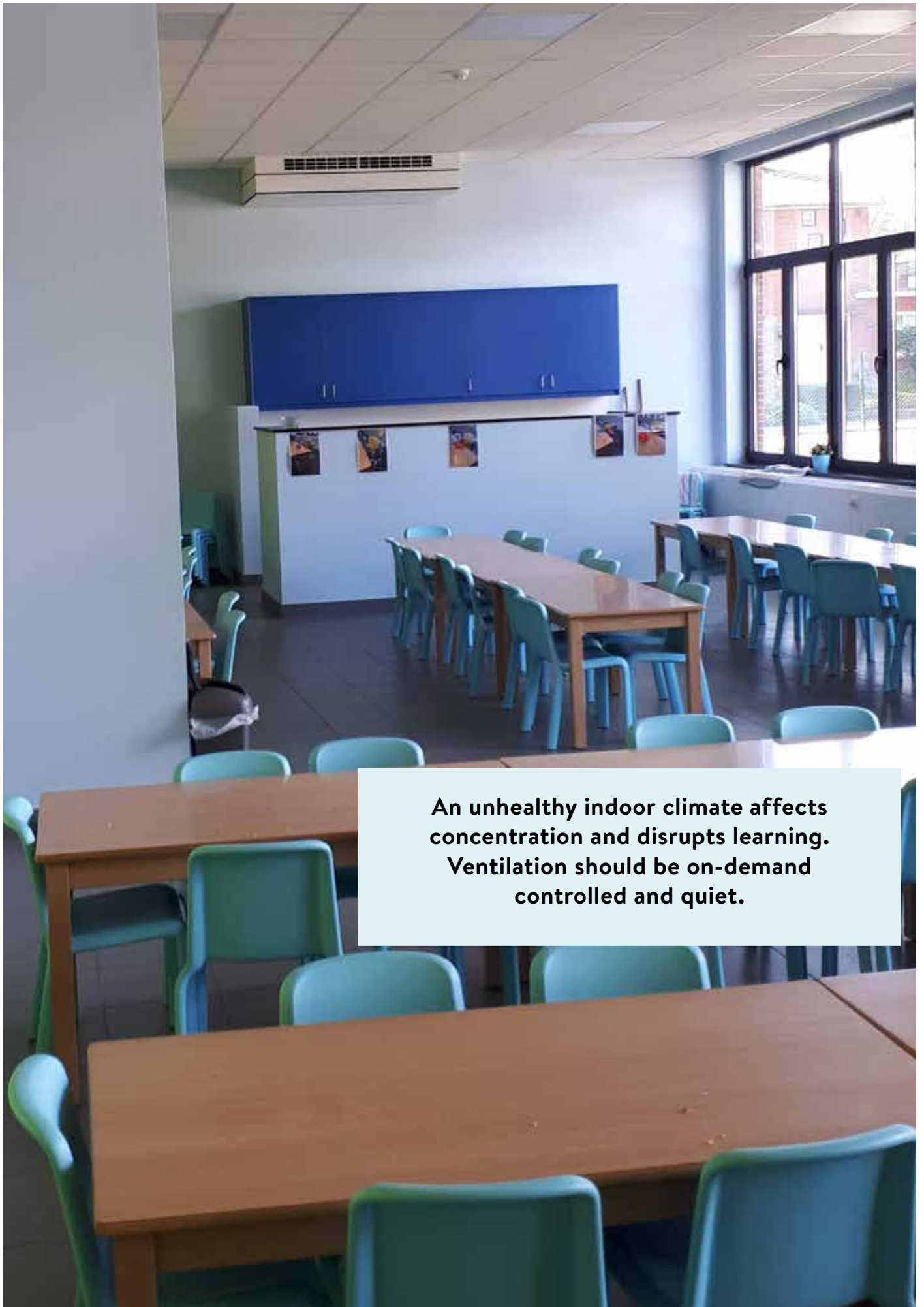

**An unhealthy indoor climate affects concentration and disrupts learning. Ventilation should be on-demand controlled and quiet.**



# AM 500

The AM 500 is designed for medium-sized rooms. A horizontal or vertical model can be installed, depending on the room and location of the unit. The air handling unit is available with a separate control panel and can also be connected to a network system (see page 108).

A cooling module can be connected (see page 24).

Ducts can be connected to extract, to inlet or to extract and inlet.



TECHNICAL DATA	FILTER CLASS	30 dB(A)	35 dB(A)
Maximum capacity	ePM <sub>10</sub> 75%	430 m <sup>3</sup> /h	550 m <sup>3</sup> /h
	ePM <sub>1</sub> 55%	387 m <sup>3</sup> /h	495 m <sup>3</sup> /h
	ePM <sub>1</sub> 80%	344 m <sup>3</sup> /h	440 m <sup>3</sup> /h
Throw length (0.2 m/s)	ePM <sub>10</sub> 75%	5,9 m at 430 m <sup>3</sup> /h	7,5 m at 550 m <sup>3</sup> /h
	ePM <sub>1</sub> 55%	5,4 m at 387 m <sup>3</sup> /h	6,7 m at 495 m <sup>3</sup> /h
	ePM <sub>1</sub> 80%	4,8 m at 344 m <sup>3</sup> /h	6,0 m at 440 m <sup>3</sup> /h
Nominal current*		1,1 A	
Nominal power consumption*		132 W	
Electrical connection		1 x 230 V + N + PE / 50 Hz	
Duct connections		Ø250 mm	
Condensate drain		Ø16 mm	
Weight		108 kg	
Counterflow heat exchanger		Aluminium	
Supply air filter		ePM <sub>10</sub> 75%, ePM <sub>1</sub> 55% or ePM <sub>1</sub> 80%	
Extract air filter		ePM <sub>10</sub> 75%	
Colour, casing		RAL 9010 (white)	
Power cable		3 x 1,5 mm <sup>2</sup>	
Recommended fuse		10 A	
Leakage current		≤ 6 mA	
Air leakage classification		Class L2 cf. EN1886:2007	
		Class A2 cf. EN 13141-7:2010	
Dimensions (WxHxD)		1600 x 439 x 779 mm	

\* At filter class, supply air/extract air: ePM<sub>10</sub> 75% / ePM<sub>10</sub> 75%

ELECTRIC HEATING SURFACE	PRE-HEATER	COMFORT HEATER
Heat output	1000 W	630 W
Thermal circuit breaker, aut. reset	75°C	75°C
Thermal circuit breaker, man. reset	120°C	120°C

WATER HEATING SURFACE	COMFORT HEATER
Max. operating temperature	90°C
Max. operating pressure	10 bar
Heat output	858 W*
Connection dimension	3/8" (DN 10)
Materials pipes/fins	copper/aluminium
Open/close time, motor valve	60 s

\* Capacity at: supply/return temperature 60/40°C, water volume 53 l/h

STANDARD AND OPTIONS	AM 500
Bypass	X
Electric preheating surface	●
Electric comfort heating surface	●
Water heating surface	●
CO <sub>2</sub> sensor (built-in)	●
PIR/motion sensor (built-in)	●
Hygrostat	●
Condensate pump	●
Cooling module (only for horizontal model)	●
Motor driven exhaust air damper	X
Motor driven supply air damper	X
Capacitive return for motor driven damper	●
Counterflow heat exchanger (aluminium)	X
Energy meter	●
Wall / Ceiling frame	●
Mini B USB (on front of unit)	●

X : standard ● : option

# AM 500

CAPACITY with ePM<sub>10</sub> 70% + ePM<sub>10</sub> 70% filter

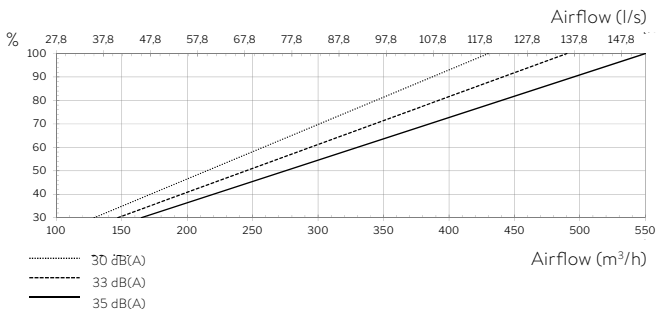

SFP

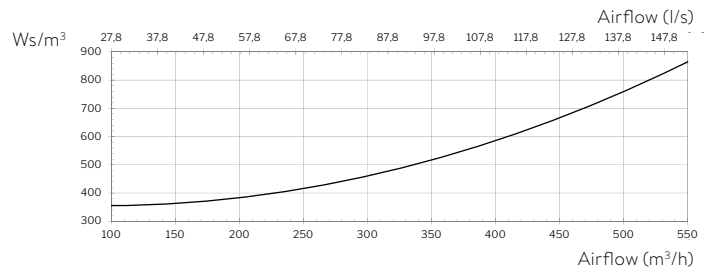

CAPACITY with ePM<sub>1</sub> 65% + ePM<sub>10</sub> 70% filter

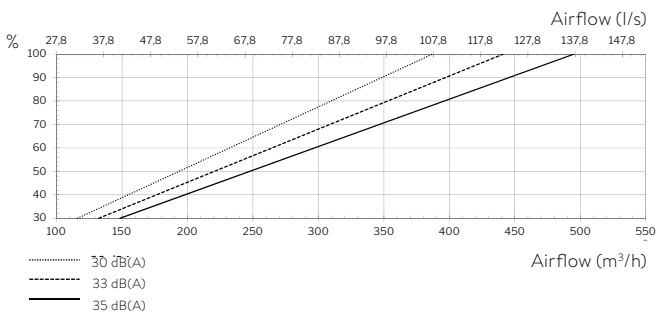

POWER CONSUMPTION

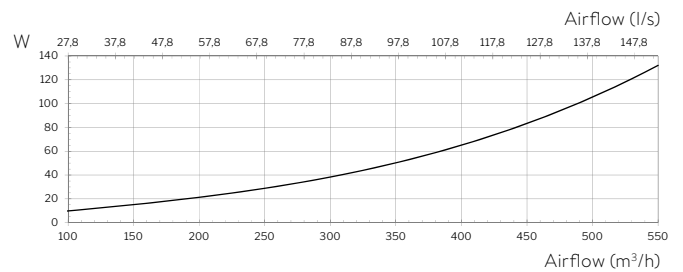

CAPACITY with ePM<sub>1</sub> 85% + ePM<sub>10</sub> 70% filter

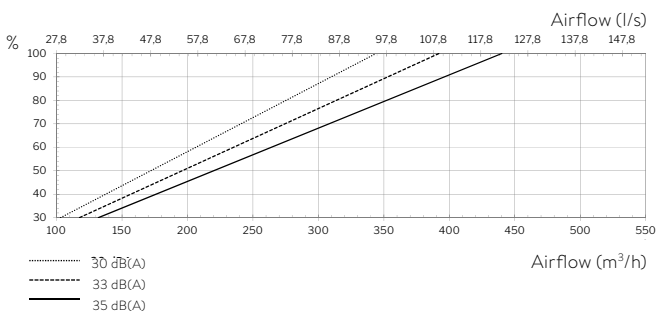

SOUND PRESSURE

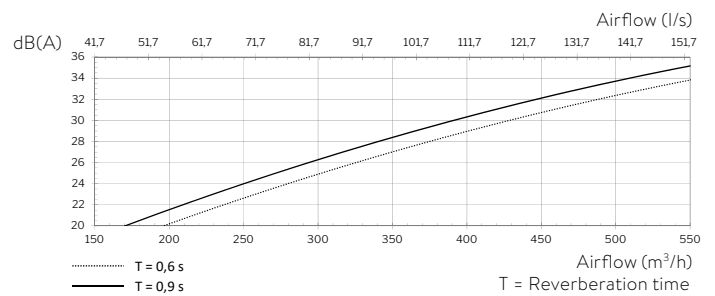

TEMPERATURE EFFICIENCY, ACC. TO EN 308:1997

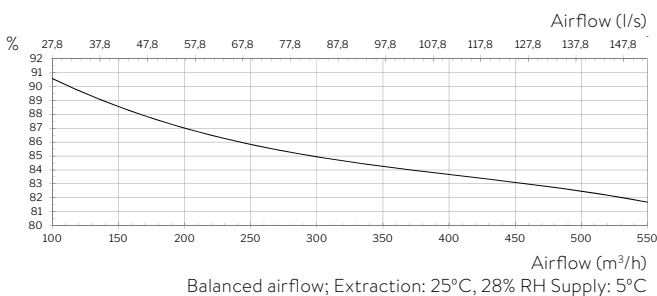

Balanced airflow; Extraction: 25°C, 28% RH Supply: 5°C

EXTERNAL PRESSURE LOSS

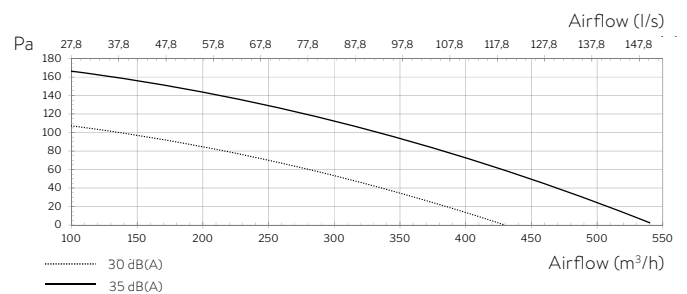

# AM 500

## THROW LENGTH

Airmaster air handling units spread an air stream in different directions, depending on the given airflow. This can be seen in the illustration on the left, in which the blue shading indicates airflows for the different throw lengths.

<sup>1</sup> Throw length seen from above

<sup>2</sup> Throw length seen from the side

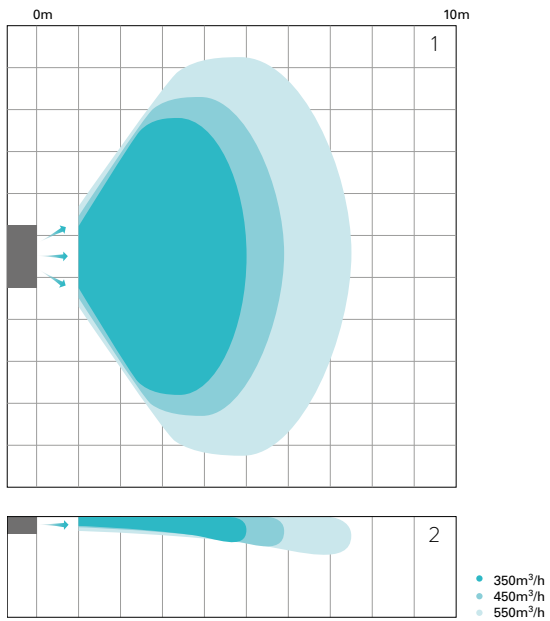

# AM 500

AM 500 HT

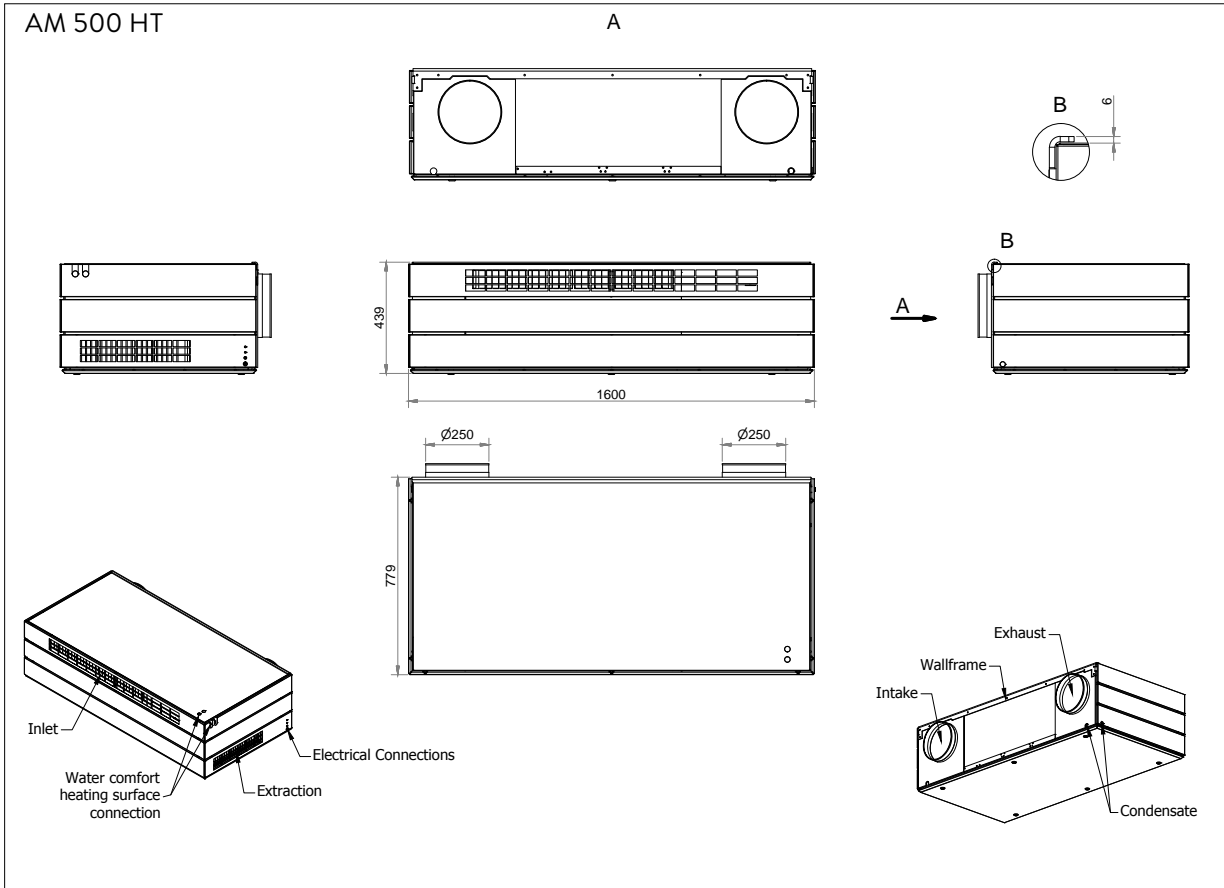

AM 500 VT

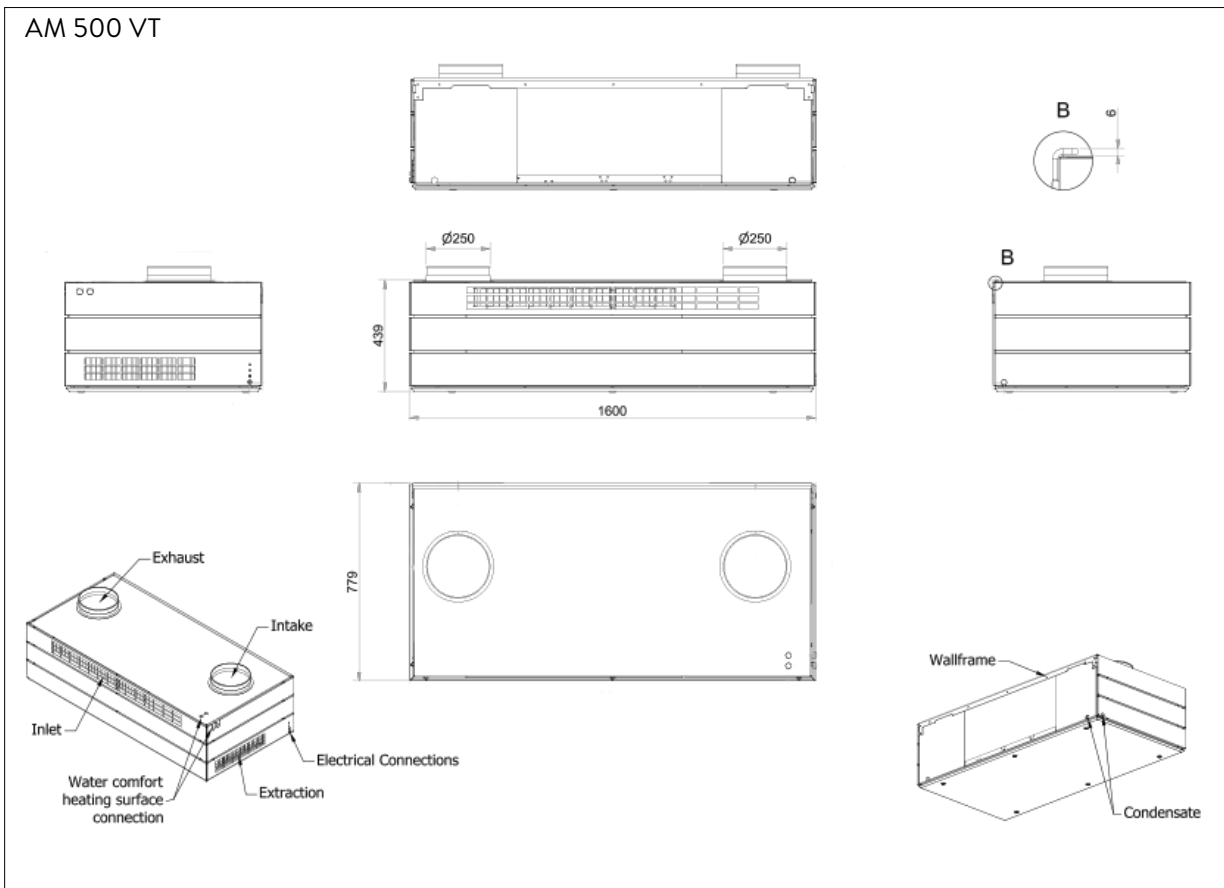

# AM 500

## SCHEMATIC SKETCH

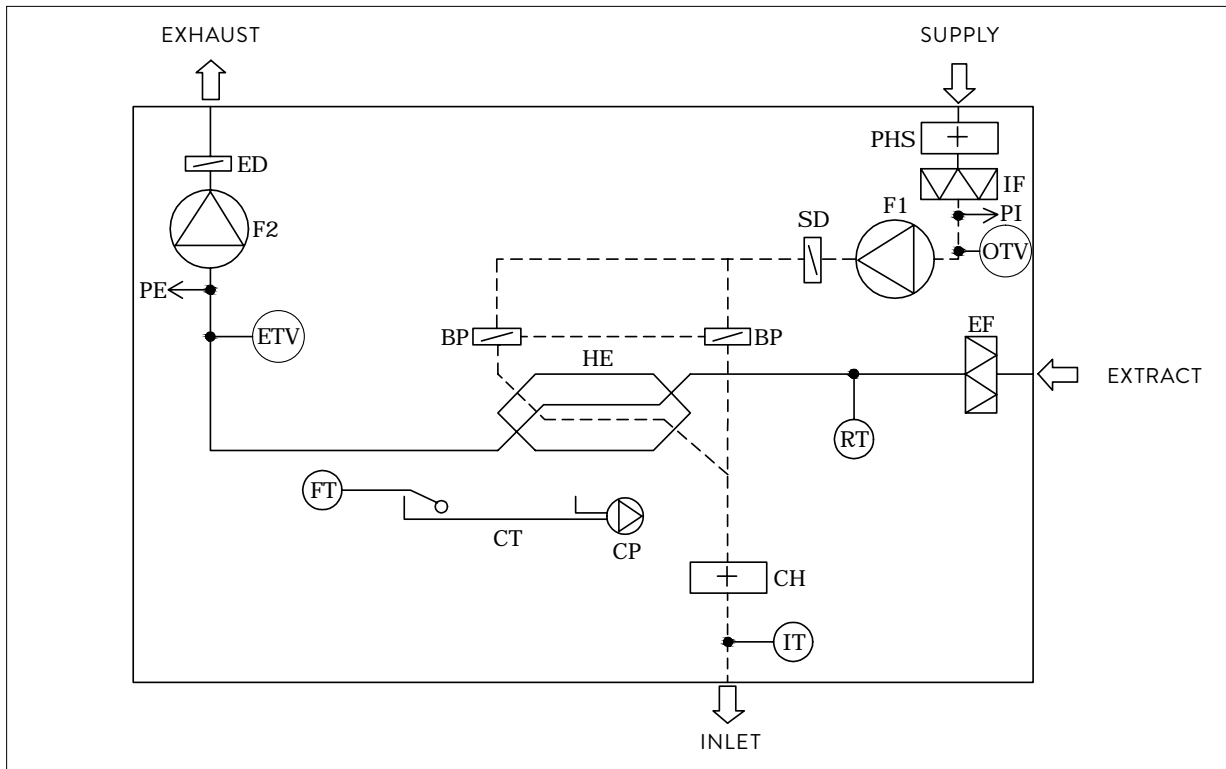

### NAME OF COMPONENT

BP	Bypass (motor driven)	ETV	Exhaust temperature sensor	OTV	Outside temperature sensor
CH	Comfort heating surface (option)	FT	Float	PE	Flow meter, extracted air (option)
CP	Condensate pump (option)	F1	Supply air fan	PHS	Preheating surface (option)
CT	Condensate tray	F2	Extract air fan	PI	Flow meter, supply air (option)
ED	Exhaust air damper (motor driven)	HE	Counterflow heat exchanger	RT	Room temperature sensor
EF	Extract air filter	IF	Supply air filter	SD	Supply air damper (motor driven)
		IT	Inlet air temperature sensor		

# CC 500 COOLING MODULE

Read more about our inverter-controlled cooling modules on page 24.

## TECHNICAL DATA

Nominal cooling capacity*	3280 W
Min. cooling capacity*	820 W
Nominal EER	3,16
Max. airflow	500 m <sup>3</sup> /h
Min. airflow**	250 m <sup>3</sup> /h
Electricity supply	1 x 230 V + N + PE / 50 Hz
Nominal electrical output	1038 W
Nominal current strength	6,4 A
Electrical output factor	0,71
Max. leakage current	2,0 mA
Coolant	R410a
Filling	480 g
Duct connection	Ø250 mm
Drain hose, internal/external diameter	Ø8/12 mm
Energy class	A*
Weight	82,8 kg
Dimensions incl. unit (WxHxD)	1600 x 439 x 1185 mm

\* Measured according to EN 308 and EN 14825 at max. airflow with ePM<sub>10</sub> 75% filter.

\*\* Cooling module activation.

## CAPACITY AM 500 + CC 500

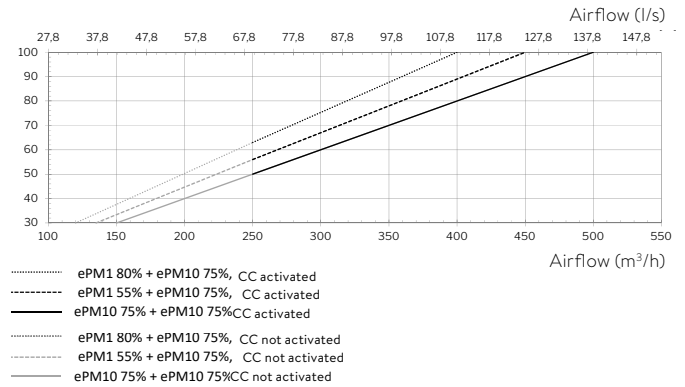

## SCHEMATIC SKETCH CC

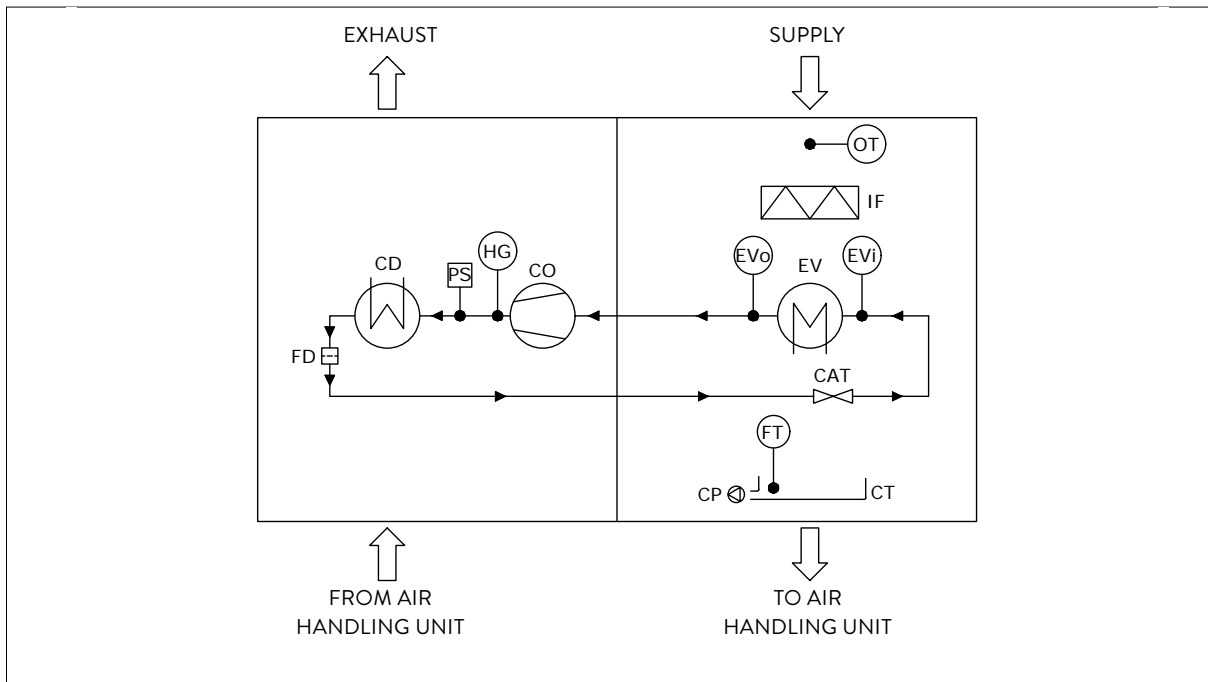

### NAME OF COMPONENT

CAT	Capillary tube	CT	Condensate tray	FT	Float
CD	Condenser	EV	Evaporator	HG	Hot gas temperature
CO	Compressor, inverter-controlled	EVI	Evaporator, temperature inlet	OT	Outside temperature
CP	Condensate pump	EVO	Evaporator, temperature output	PS	Pressure switch
		FD	Dry filter		

Lined writing area with 28 horizontal lines.



People are sensitive to changes in the air. Temperature, oxygen and CO<sub>2</sub> levels should ideally be in natural balance for the sake of our wellbeing.

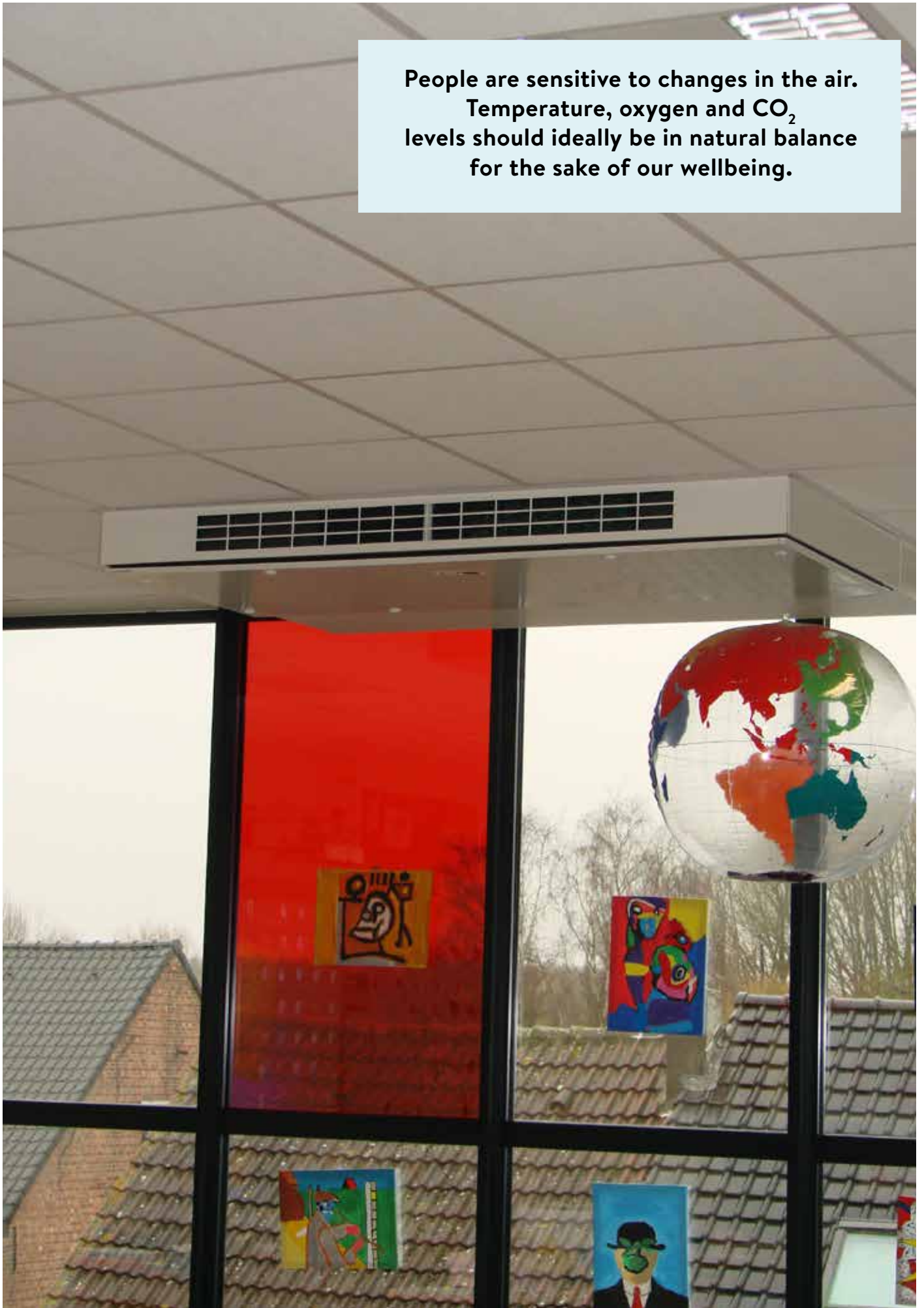

# AM 800

This air handling unit is designed for large rooms with moderate requirement and is thus perfect for classrooms. A horizontal or vertical model can be installed, depending on the room and location of the unit. The air handling unit is available with a separate control panel and can also be connected to a network system (see page 108).



A cooling module can be connected (see page 24).

Ducts can be connected to extract, to inlet or to extract and inlet.

TECHNICAL DATA	FILTER CLASS	30 dB(A)	35 dB(A)
Maximum capacity	ePM <sub>10</sub> 75%	650 m <sup>3</sup> /h	725 m <sup>3</sup> /h
	ePM <sub>1</sub> 55%	585 m <sup>3</sup> /h	653 m <sup>3</sup> /h
	ePM <sub>1</sub> 80%	520 m <sup>3</sup> /h	580 m <sup>3</sup> /h
Throw length (0.2 m/s)	ePM <sub>10</sub> 75%	7,7 m at 650 m <sup>3</sup> /h	8,3 m at 725 m <sup>3</sup> /h
	ePM <sub>1</sub> 55%	7,2 m at 585 m <sup>3</sup> /h	7,7 m at 653 m <sup>3</sup> /h
	ePM <sub>1</sub> 80%	6,7 m at 520 m <sup>3</sup> /h	7,2 m at 580 m <sup>3</sup> /h
Nominal current*		1,1 A	
Nominal power consumption*		156 W	
Electrical connection		1 x 230 V + N + PE / 50 Hz	
Duct connections		Ø315 mm	
Condensate drain		Ø16 mm	
Weight		157 kg	
Counterflow heat exchanger		2 x Aluminium	
Supply air filter		ePM <sub>10</sub> 75%, ePM <sub>1</sub> 55% or ePM <sub>1</sub> 80%	
Extract air filter		ePM <sub>10</sub> 75%	
Colour, casing		RAL 9010 (white)	
Power cable		3 x 1,5 mm <sup>2</sup>	
Recommended fuse		13 A	
Leakage current		≤ 6 mA	
Air leakage classification		Class L2 cf. EN 1886:2007	
		Class A1 cf. EN 13141-7:2010	
Dimensions (WxHxD)		1910 x 474 x 916 mm	

\* At filter class, supply air/extract air: ePM<sub>10</sub> 75% / ePM<sub>10</sub> 75%

ELECTRIC HEATING SURFACE	PRE-HEATER	COMFORT HEATER
Heat output	1500 W	1000 W
Thermal circuit breaker, aut. reset	75°C	75°C
Thermal circuit breaker, man. reset	120°C	120°C

WATER HEATING SURFACE	COMFORT HEATER
Max. operating temperature	90°C
Max. operating pressure	10 bar
Heat output	1379 W*
Connection dimension	1/2" (DN 15)
Materials pipes/fins	copper/aluminium
Open/close time, motor valve	60 s

\* Capacity at: supply/return temperature 60/40°C, water volume 60 l/h

STANDARD AND OPTIONS	AM 800
Bypass	X
Electric preheating surface	●
Electric comfort heating surface	●
Water heating surface	●
CO <sub>2</sub> sensor (built-in)	●
PIR/motion sensor (built-in)	●
Hygrostat	●
Condensate pump	●
Cooling module (only for horizontal model)	●
Motor driven exhaust air damper	X
Motor driven supply air damper	X
Capacitive return for motor driven damper	●
Counterflow heat exchanger	X
Wall / Ceiling frame	●
Energy meter	●
Mini B USB (on front of unit)	●
Boomerain Ø315	●

X : standard ● : option

# AM 800

CAPACITY with ePM<sub>10</sub> 70% + ePM<sub>10</sub> 70% filter

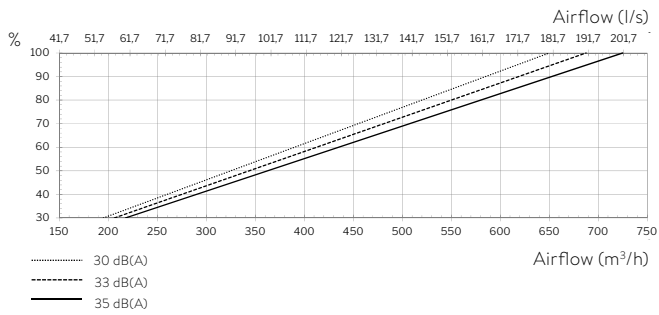

SFP

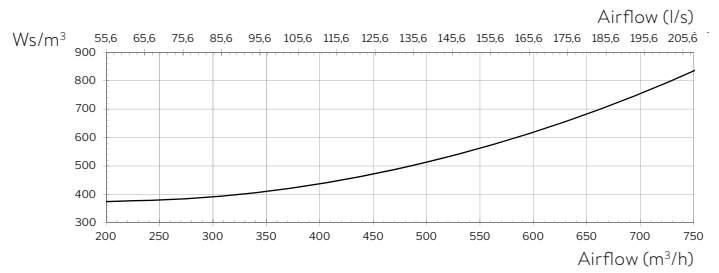

CAPACITY with ePM<sub>1</sub> 65% + ePM<sub>10</sub> 70% filter

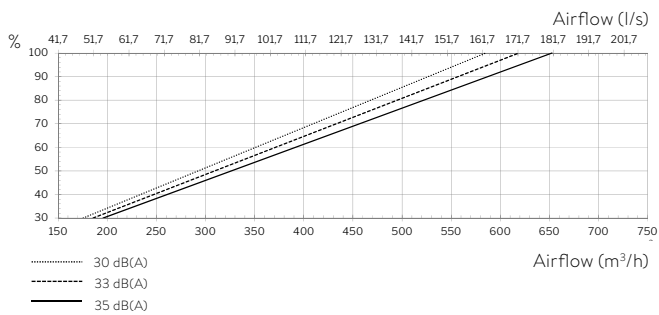

POWER CONSUMPTION

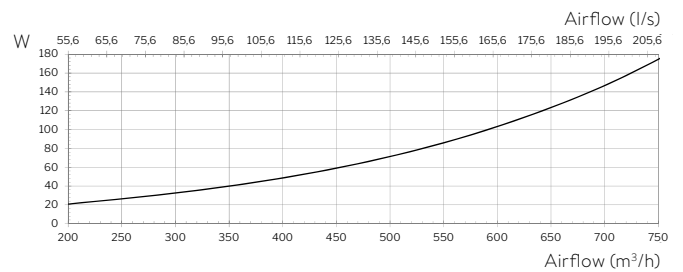

CAPACITY with ePM<sub>1</sub> 85% + ePM<sub>10</sub> 70% filter

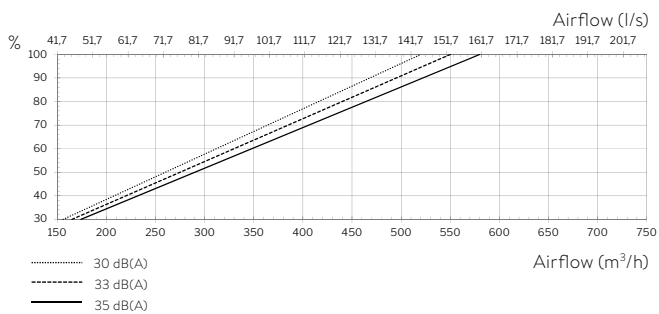

SOUND PRESSURE

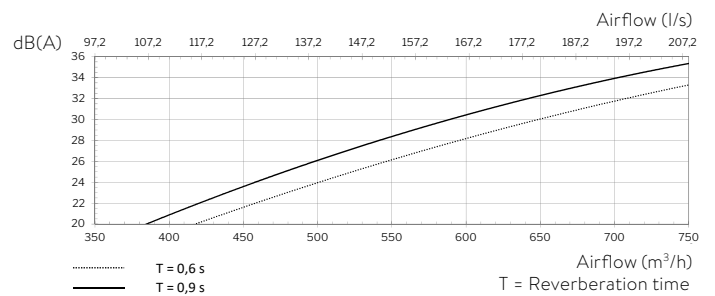

TEMPERATURE EFFICIENCY, ACC. TO EN 308:1997

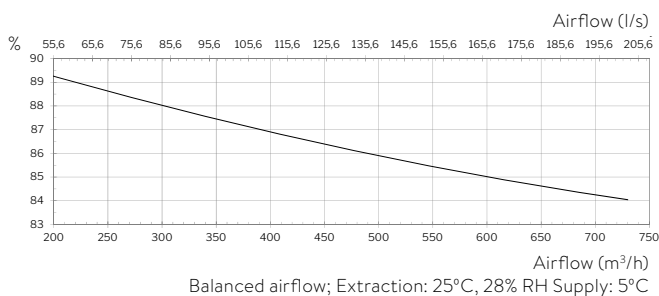

EXTERNAL PRESSURE LOSS

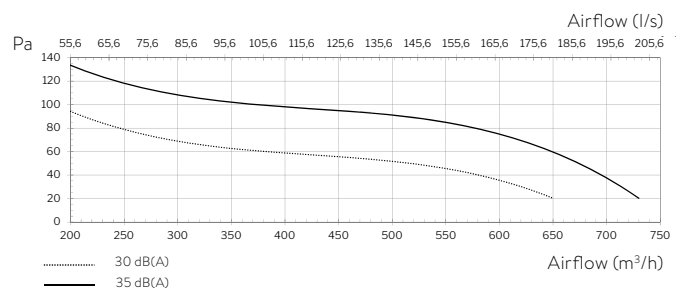

# AM 800

Sound pressure level,  $L_{WA}$  [dB(A)], acc. EN/ISO 3744

Frekvens (Hz)	63	125	250	500	1000	2000	4000	8000	$\emptyset L_{WA}$	$L_{p,eq}^{2,3}$	$q_v$ [m³/h]
filter:	28	33	28	30	25,1	20,2	19,9	18,3	36,8	30	650
ePM <sub>10</sub> 75% + ePM <sub>10</sub> 75%	31	35	31	32	28	23,7	21	18,8	39,2	33	688
	33	39	34	34	31,8	25,9	22,8	19,1	42,1	35	725
filter:	29	33	27	29	25,4	19,7	19,8	18,3	36,8	30	585
ePM, 55% + ePM <sub>10</sub> 75%	31	36	32	32	28,1	22,8	20,9	18,8	39,8	33	619
	34	39	33	35	32,3	25	22,5	19	42,6	35	653

$L_{p,eq}$  Sound pressure level [dB(A)] at 1m distance.

## THROW LENGTH

Airmaster air handling units spread an air stream in different directions, depending on the given airflow. This can be seen in the illustration on the left, in which the blue shading indicates airflows for the different throw lengths.

<sup>1</sup> Throw length seen from above

<sup>2</sup> Throw length seen from the side

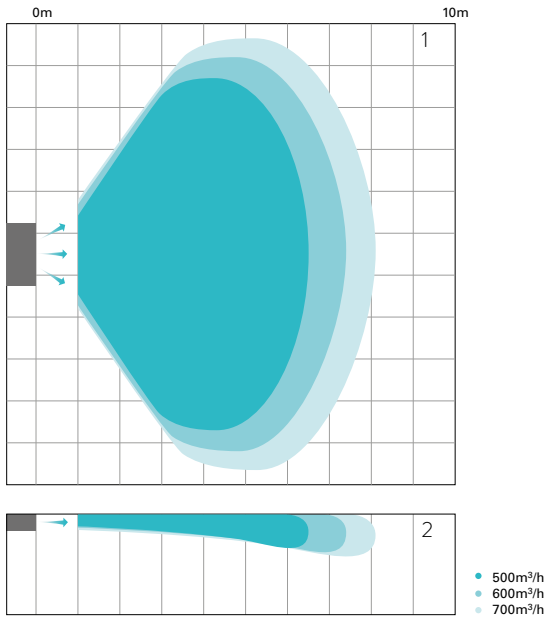

# AM 800

AM 800 HT

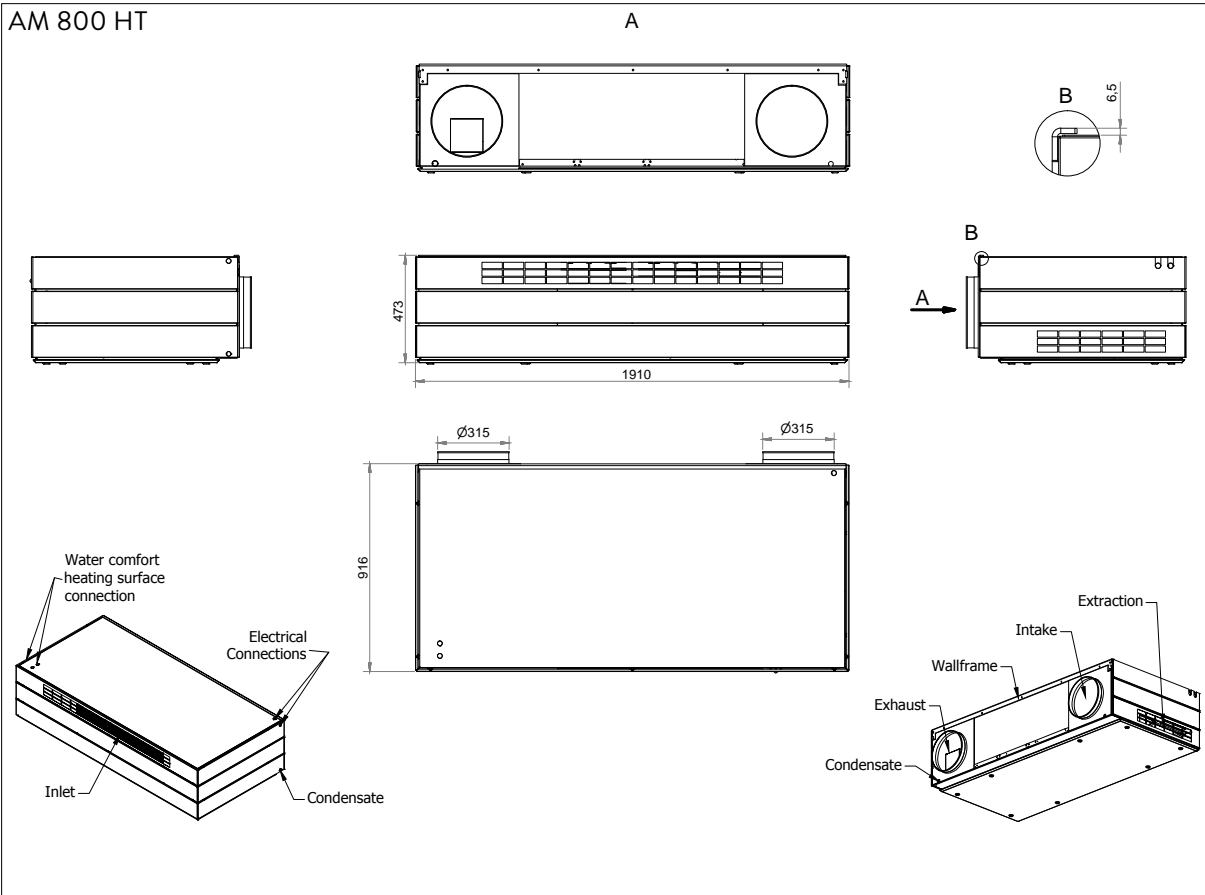

AM 800 VT

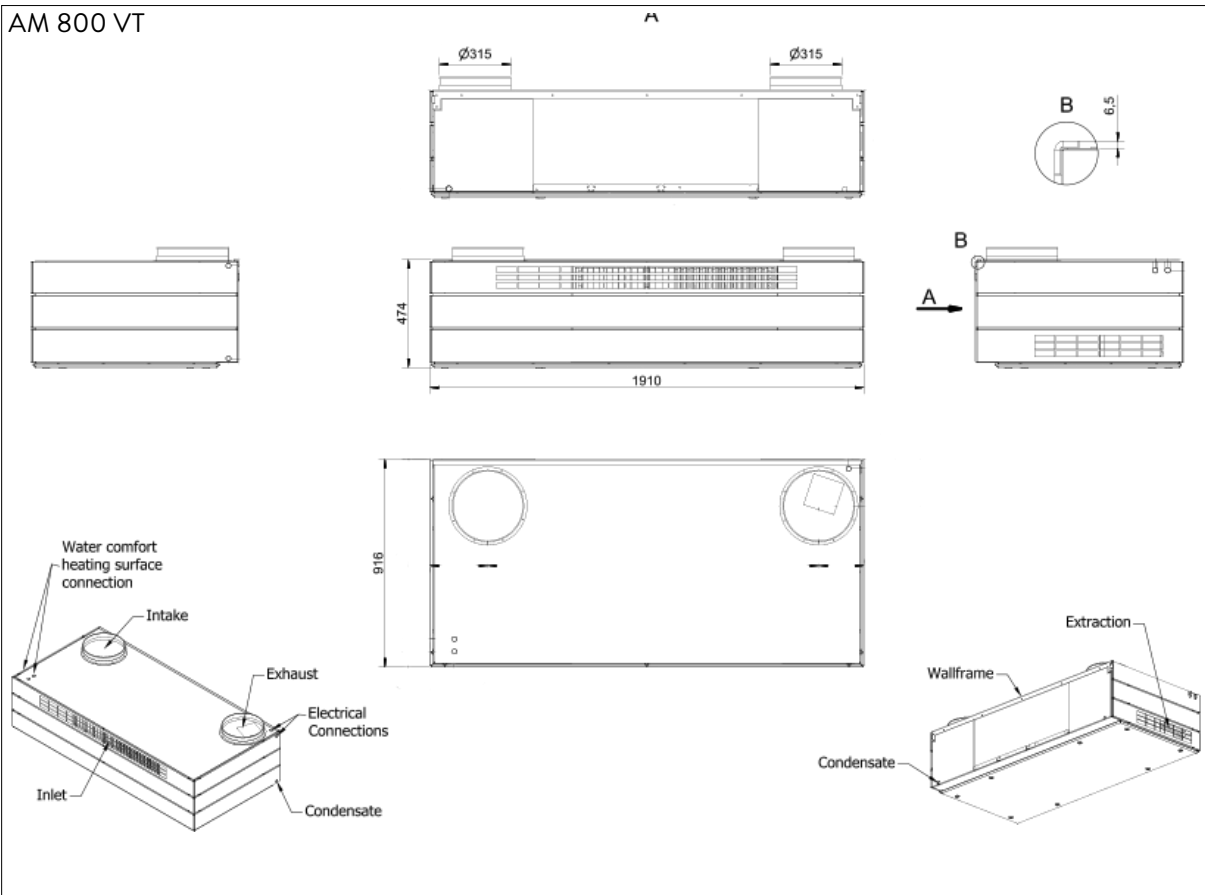

# AM 800

## SCHEMATIC SKETCH

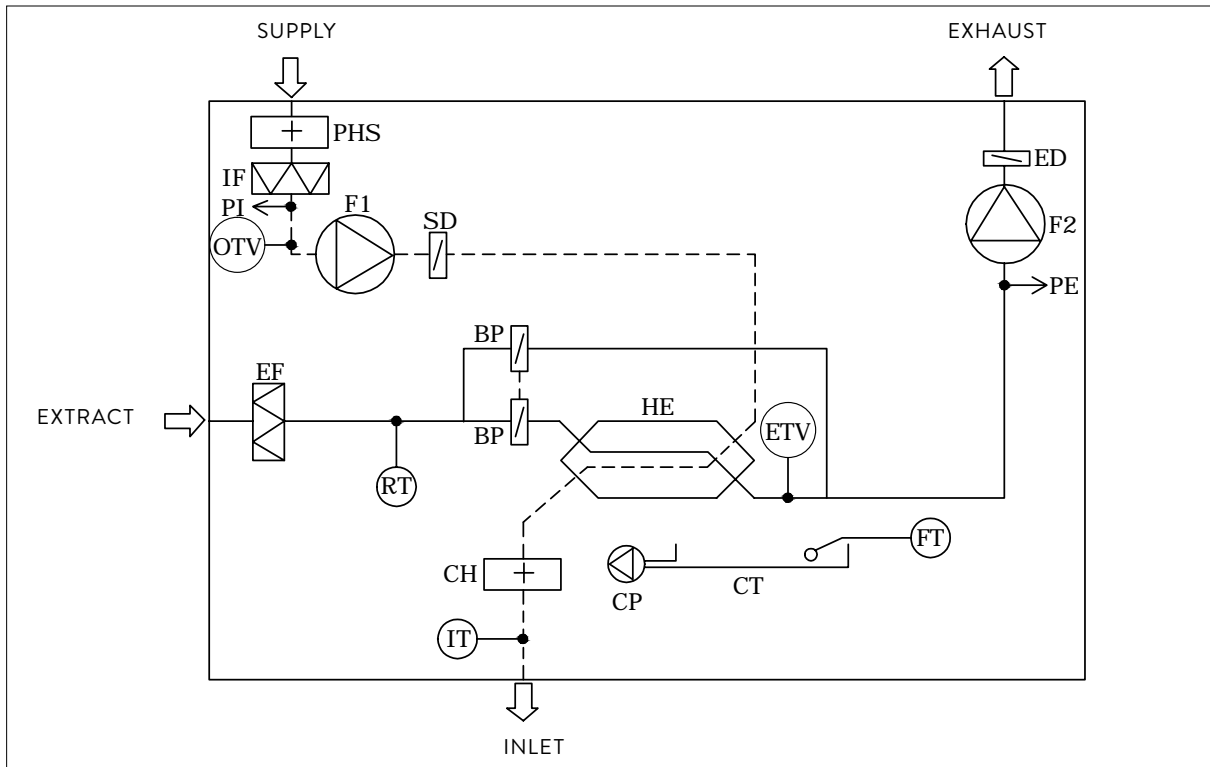

### NAME OF COMPONENT

BP	Bypass (motor driven)	ETV	Exhaust temperature sensor	OTV	Outside temperature sensor
CH	Comfort heating surface (option)	FT	Float	PE	Flow meter, extracted air (option)
CP	Condensate pump (option)	F1	Supply air fan	PHS	Preheater surface (option)
CT	Condensate tray	F2	Extract air fan	PI	Flow meter, supply air (option)
ED	Exhaust air damper (motor driven)	HE	Counterflow heat exchanger	RT	Room temperature sensor
EF	Extract air filter	IF	Supply air filter	SD	Supply air damper (motor driven)
		IT	Inlet air temperature sensor		

# CC 800 COOLING MODULE

Read more about our inverter-controlled cooling modules on page 24.

## TECHNICAL DATA

Nominal cooling capacity*	5240 W
Min. cooling capacity*	990 W
Nominal EER	4,72
Max. airflow	650 m <sup>3</sup> /h
Min. airflow**	260 m <sup>3</sup> /h
Electricity supply	1 x 230 V + N + PE / 50 Hz
Nominal electrical output	1110 W
Nominal current strength	6,8 A
Electrical output factor	0,71
Max. leakage current	2,0 mA
Coolant	R410a
Filling	820 g
Duct connection	Ø315 mm
Drain hose, internal/external diameter	Ø8/12 mm
Energy class	A+++
Weight	100,7 kg
Dimensions incl. unit (WxHxD)	1910 x 474 x 1321 mm

\* Measured according to EN 308 and EN 14825 at max. airflow with ePM<sub>10</sub> 75% filter.

\*\* Cooling module activation.

CAPACITY AM 800 + CC 800

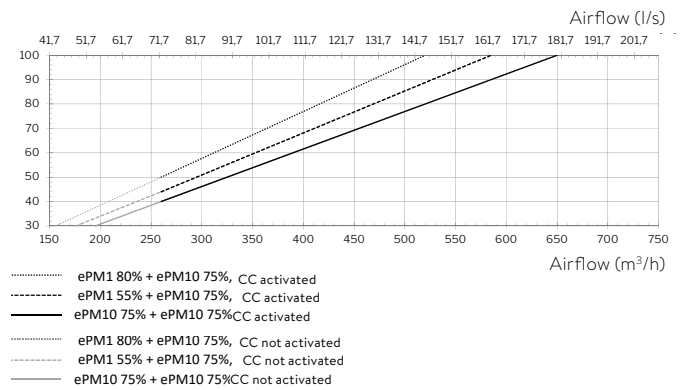

## SCHEMATIC SKETCH CC

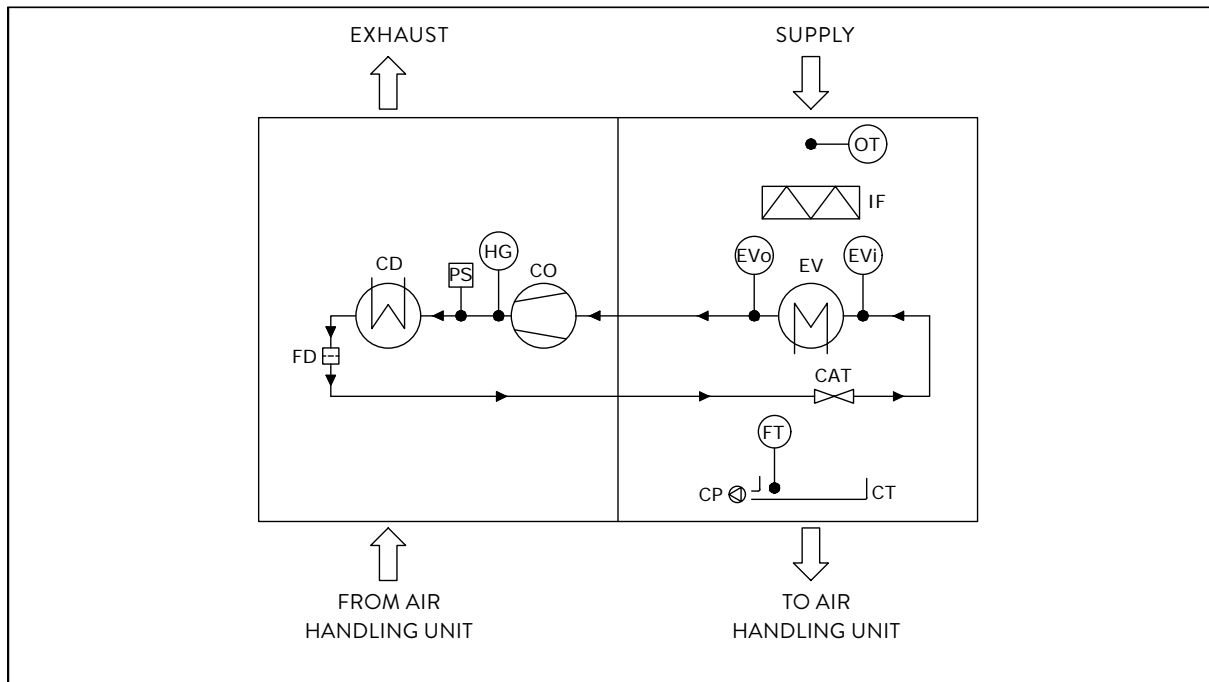

### NAME OF COMPONENT

CAT	Capillary tube	CT	Condensate tray	FT	Float
CD	Condenser	EV	Evaporator	HG	Hot gas temperature
CO	Compressor, inverter-controlled	EVi	Evaporator, temperature inlet	OT	Outside temperature
CP	Condensate pump	EVo	Evaporator, temperature output	PS	Pressure switch
		FD	Dry filter		







**The AM 1000 comes in four sections. The unit is therefore easy to transport, handle and install.**

# AM 1000

AM 1000 is a highly competitive solution developed for ventilation in classrooms, but can of course be used anywhere there are high requirements for comfort and healthy indoor climate.

## Active noise control

The active noise control technology is excellent at damping low-frequency noise, which normally requires a large damper area.



TECHNICAL DATA	FILTER CLASS	30 dB(A)	35 dB(A)
Maximum capacity	ePM <sub>10</sub> 75%	950 m <sup>3</sup> /h	1050 m <sup>3</sup> /h
	ePM <sub>1</sub> 55%	926 m <sup>3</sup> /h	1024 m <sup>3</sup> /h
	ePM <sub>1</sub> 80%	903 m <sup>3</sup> /h	998 m <sup>3</sup> /h
Throw length (0,2 m/s)		10,5 m	10,5 m
Nominal current*		2,2 A	
Nominal power consumption*		305 W	
Electrical connection		3 x 400 V + N + PE / 50 Hz	
Duct connections		Ø315 mm**	
Condensate drain, int./ext.		Ø4/6 mm	
Weight, standard unit complete		301,5 kg	
Counterflow heat exchanger		2 x Aluminium	
Supply air filter		ePM <sub>10</sub> 75%, ePM <sub>1</sub> 55% or ePM <sub>1</sub> 80%	
Extract air filter		ePM <sub>10</sub> 75%	
Colour, panel		RAL 9010 (white)	
Power cable		5 x 2,5 mm <sup>2</sup>	
Recommended fuse		3 x 13 A	
Leakage current		≤ 4 mA	
Air leakage classification		Class L2 cf. EN 1886:2007	
		Class A1 cf. EN 13141-7:2010	
Dimensions (WxHxD)		2325 x 561 x 1283 mm	

\* At filter class, supply air/extract air: ePM<sub>10</sub> 75% / ePM<sub>10</sub> 75% - ePM<sub>1</sub> 55% / ePM<sub>10</sub> 75% - ePM<sub>1</sub> 80% / ePM<sub>10</sub> 75%

\*\* Horizontal supply/exhaust using Airmaster Boomerain® Ø315 or Ø400 mm wall grille.

ELECTRIC HEATING SURFACE	PRE-HEATER	COMFORT HEATER
Heat output	2300 W	1500 W
Thermal circuit breaker, aut. reset	75°C	75°C
Thermal circuit breaker, man. reset	120°C	120°C

## WATER HEATING SURFACE

Max. operating temperature	90°C
Max. operating pressure	10 bar
Heat output	2540 W*
Connection dimension	1/2" (DN 15)
Materials pipes/fins	kobber/aluminium
Open/close time, motor valve	60 s

\* Capacity at: supply/return temperature 60/40°C, water volume 112 l/h

STANDARD AND OPTIONS	AM 1000
Bypass	X
Adaptive Airflow™	●
Electric preheating surface	●
Electric comfort heating surface	●
Water heating surface	●
CO <sub>2</sub> sensor (built-in)	●
PIR/motion sensor (built-in)	●
Condensate pump	●
Motor driven exhaust air damper	X
Motor driven supply air damper	X
Counterflow heat exchanger (aluminium)	X
Wall / Ceiling frame	X
Energy meter	●
Boomerain Ø315	●

X : standard ● : option

# AM 1000 VERSIONS

## Versions exhaust / supply

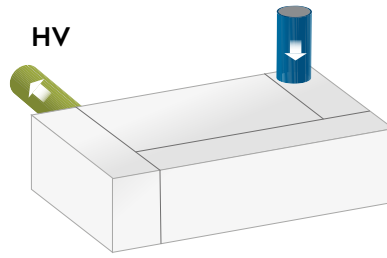
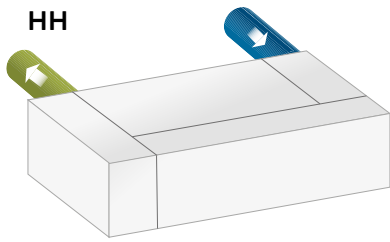

- H Horizontal
- V Vertical
- S1 Side (towards the rear)
- S2 Side (towards the front)
- 1 Exhaust
- 2 Supply

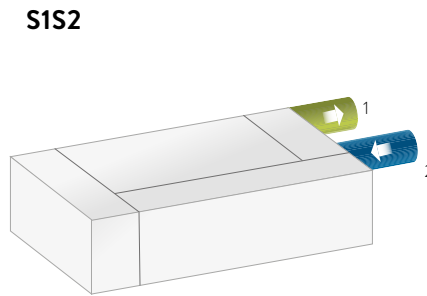
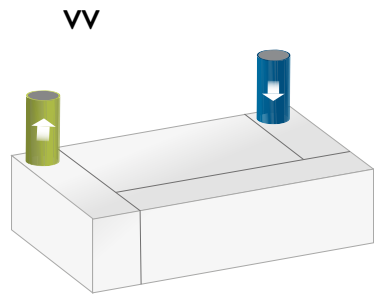

## Versions inlet / extract

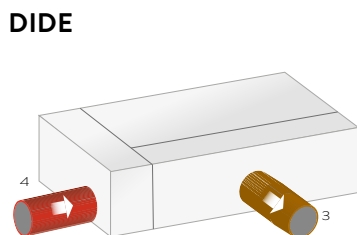
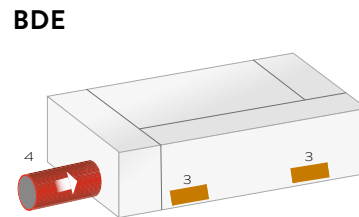
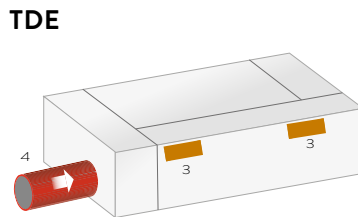
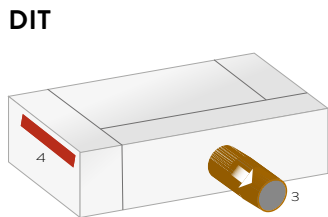
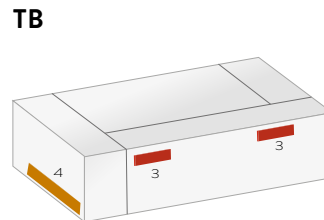
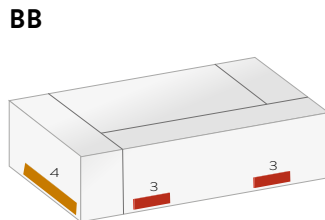
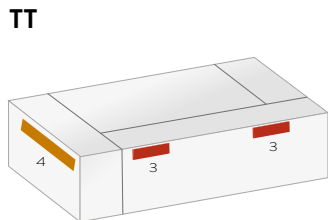

- TT Inlet / extract on top
- BB Inlet / extract at the bottom
- TB Inlet on top / extract at the bottom
- DIT Inlet ducted / extract on top
- TDE Inlet on top / extract ducted
- BDE Inlet at the bottom / extract ducted
- DIDE Inlet / extract ducted
- 3 Inlet
- 4 Extract

# AM 1000 THROW LENGTH

Variable inlet with AM 1000. Inlet divided via two separate inlet grilles, each of which forms a stream. Both grilles have variable louvres. The streams achieve maximum spread at full airflow. This tends to cause a short throw length. The streams are concentrated together when a small airflow is used, which tends to cause a long throw length. Adjustment is gradual and automatic, based on the built-in flow metering. This method ensures an almost constant throw length adapted to the length of the room.

## SYMMETRIC MOUNTING IN THE ROOM WITH ADAPTIVE AIRFLOW™

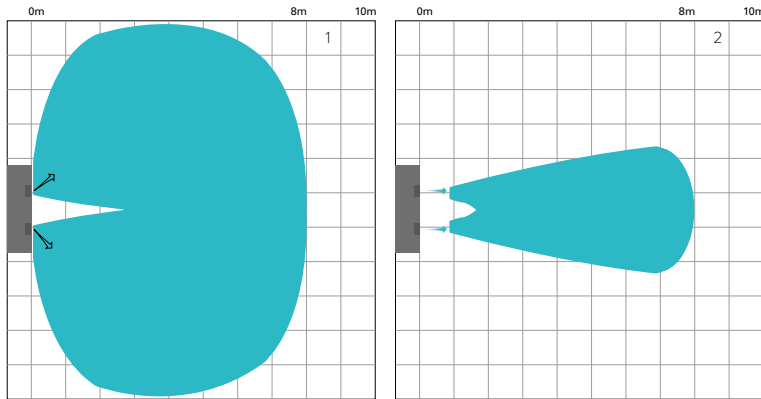

- <sup>1</sup> At maximum air volume with separate streams.
- <sup>2</sup> At minimum air volume with concentrated streams.

## ASYMMETRIC MOUNTING IN THE ROOM WITH ADAPTIVE AIRFLOW™

If the type of room or building only makes asymmetric mounting possible, we recommend to order a directional inlet grille. Use the following sketches as a guideline.

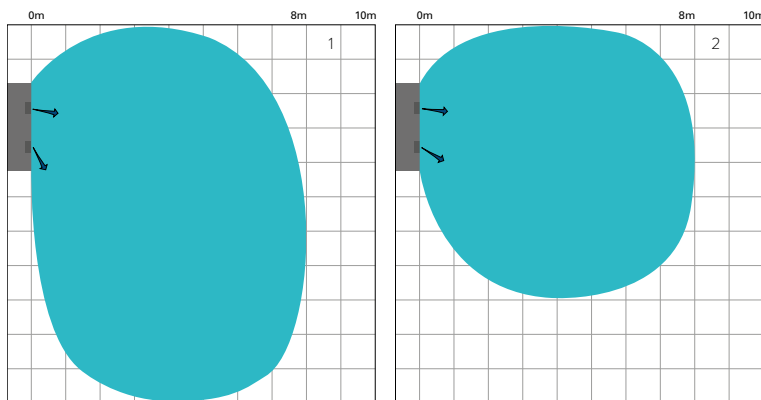

- <sup>1</sup> At maximum air volume with separate streams.
- <sup>2</sup> At minimum air volume with concentrated streams.

### THROW LENGTH

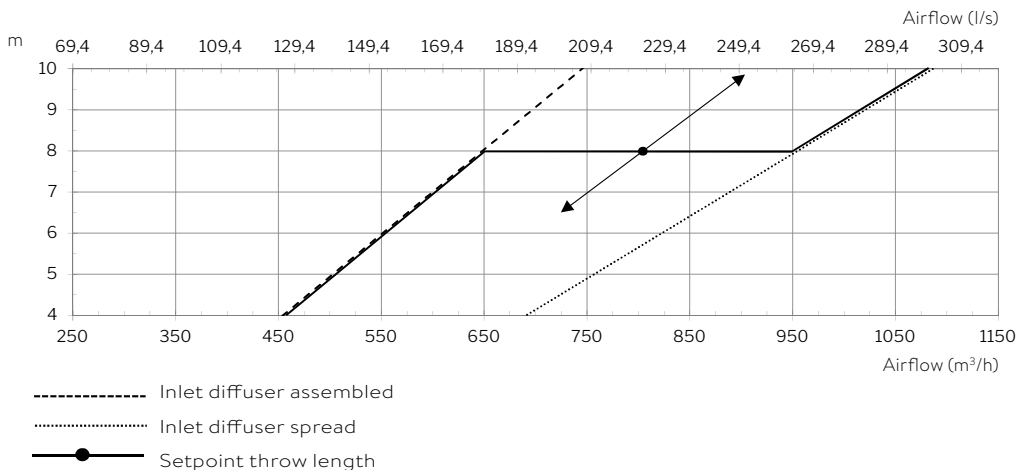

The throw length is measured with 2°C subcooled inlet. Throw length set as standard to 8 m. Set point for throw length can be adjusted using a PC with Airlinq Service Tool installed.

# AM 1000

CAPACITY with ePM<sub>10</sub> 70% + ePM<sub>10</sub> 70% filter

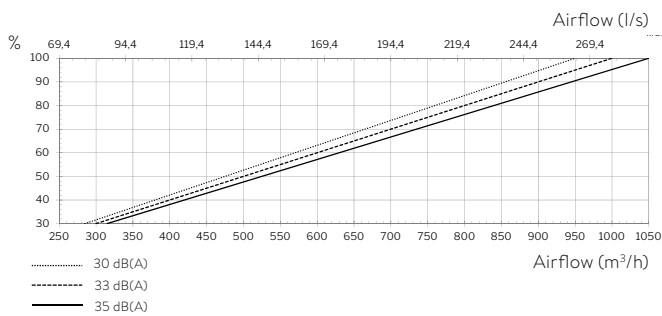

TEMPERATURE EFFICIENCY, ACC. TO EN 308:1997

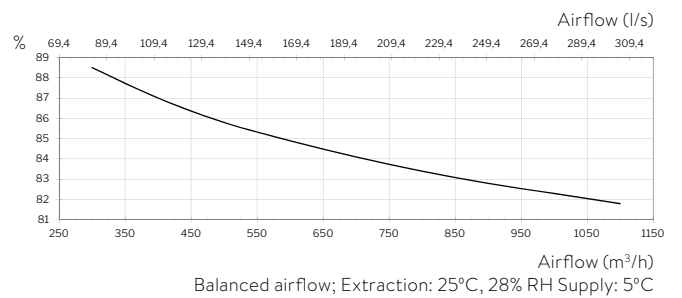

CAPACITY with ePM<sub>1</sub> 65% + ePM<sub>10</sub> 70% filter

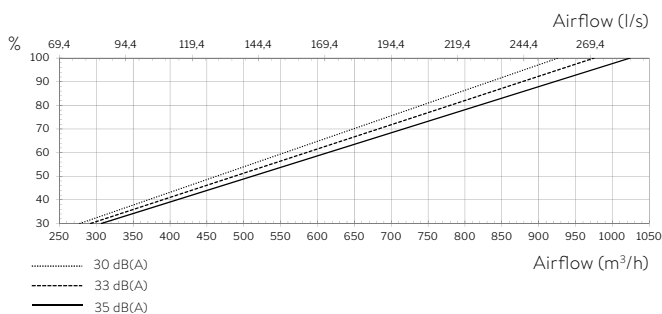

POWER CONSUMPTION

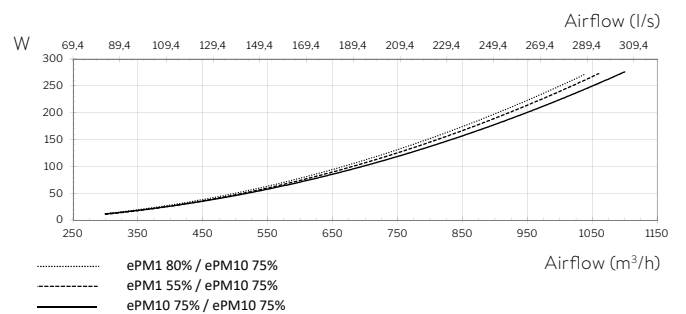

CAPACITY with ePM<sub>1</sub> 85% + ePM<sub>10</sub> 70% filter

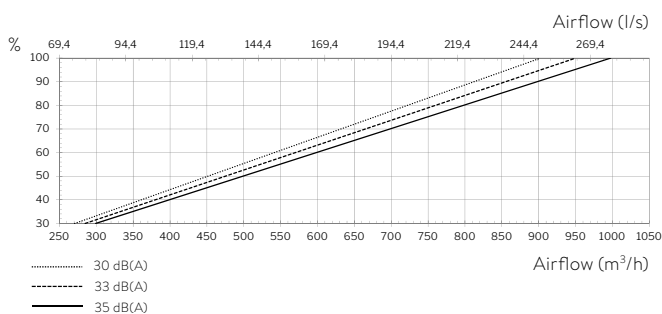

Sound pressure level, L<sub>WA</sub> [dB(A)], acc. ISO 9614-1

Frekvens (Hz)	63	125	250	500	1000	2000	4000	8000	Samlet
L <sub>WA</sub> [dB(A)]	31,2	38,3	38,2	36,7	31,6	23,4	14,1	7,7	43,2

Data for the whole unit (including top) at 950 m<sup>3</sup>/h flow with ePM<sub>10</sub> 75% / ePM<sub>10</sub> 75% filters and standard grilles. A simplified calculation model which assumes a point source may for AM 1000 result in overestimation of sound pressure, especially if sound absorbing surfaces are located close to the unit.

Measurements taken with unit model AM 1000 HHT built-in as standard using Airmaster's recommended wall grille 400 mm dia.

# AM 1000

SFP with ePM<sub>10</sub> 75% supply air filter and ePM<sub>10</sub> 75% extract air filter:<sup>1</sup>

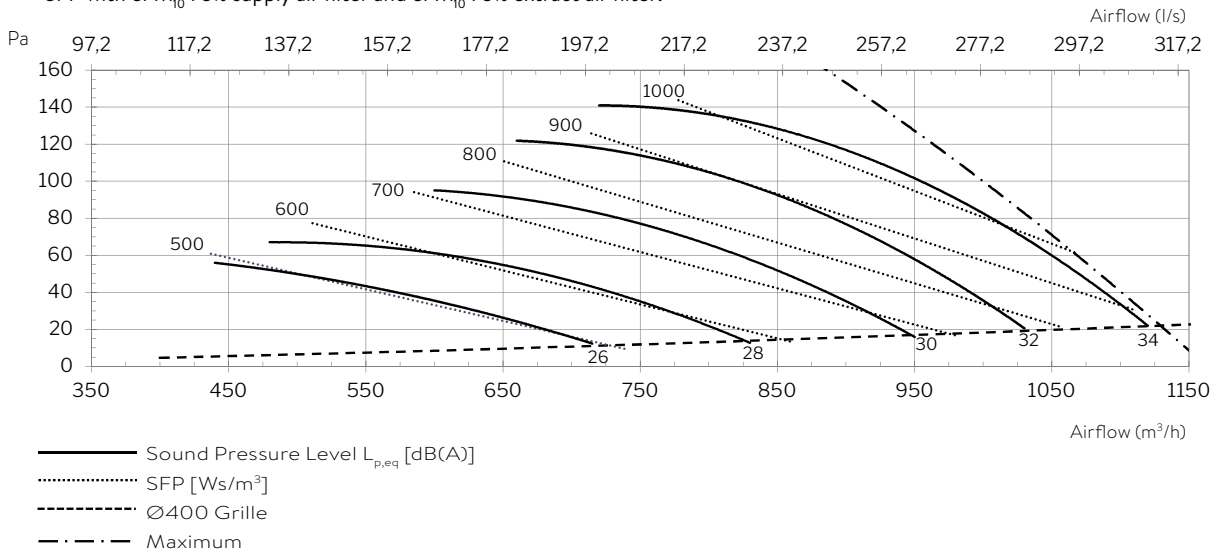

SFP with ePM<sub>1</sub> 55% supply air filter and ePM<sub>10</sub> 75% extract air filter:<sup>1</sup>

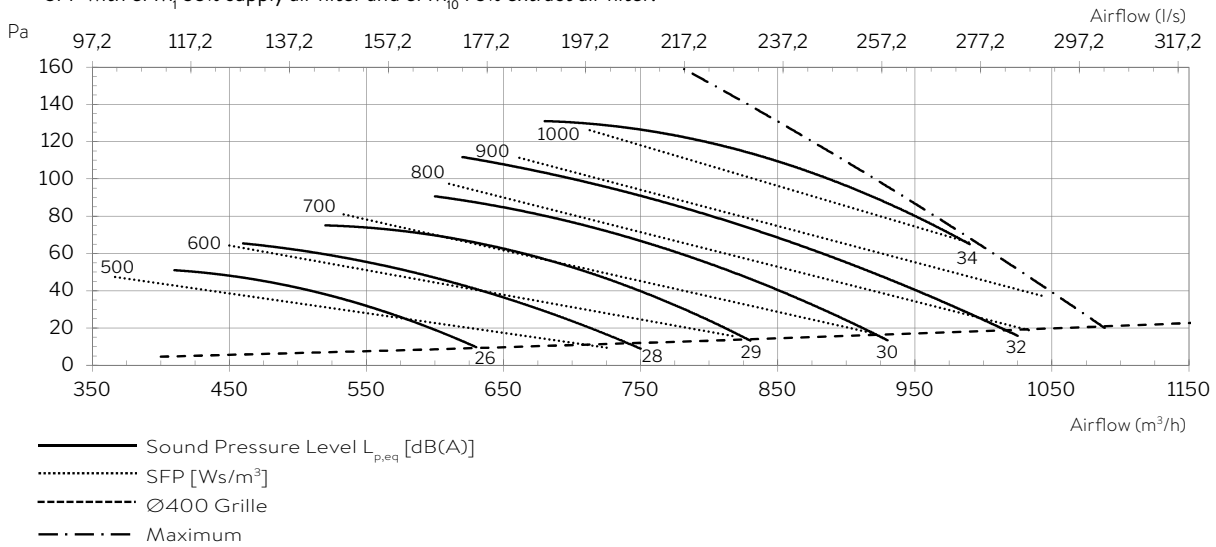

SFP with ePM<sub>1</sub> 80% supply air filter and ePM<sub>10</sub> 75% extract air filter:<sup>1</sup>

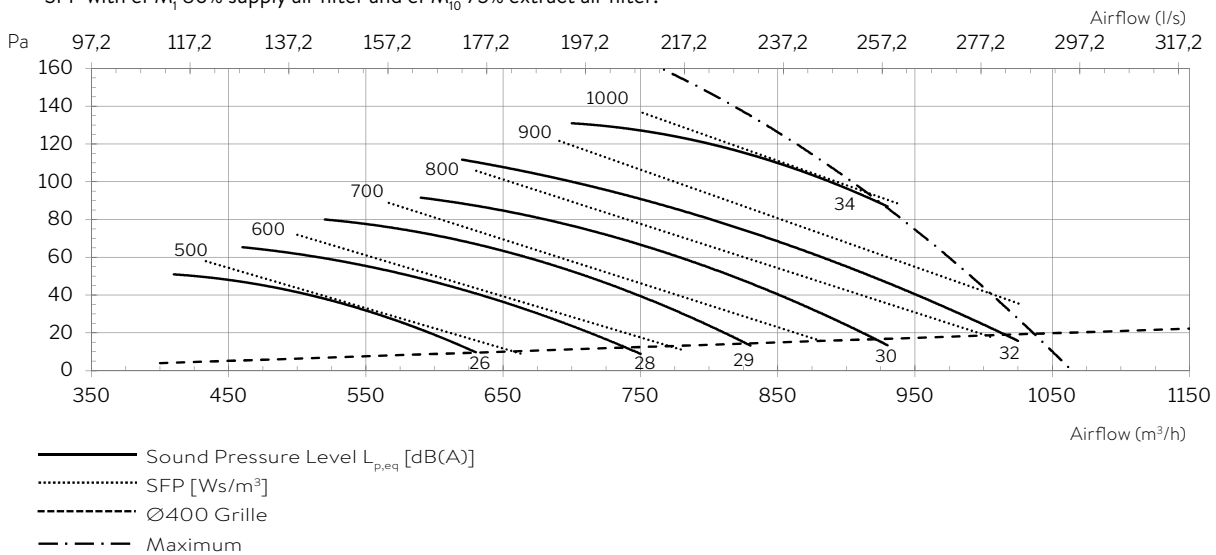

<sup>1</sup> Measurements taken with unit model AM 1000 HHT built-in as standard using Airmaster's recommended wall grille 400 mm dia. Sound pressure  $L_{p,eq}$  is measured at a height of 1.2 m with 1 m horizontal distance from unit with room damping of 9 dB(A).



# AM 1000

AM 1000 HHTT

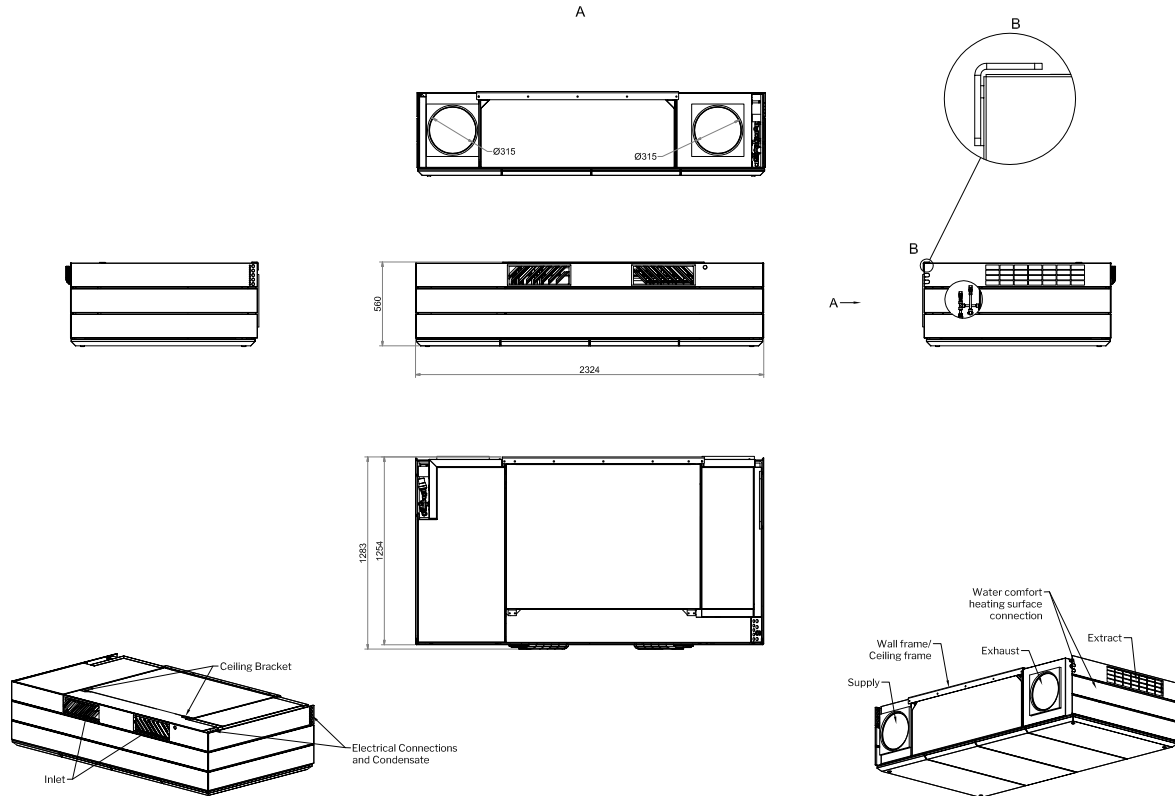

Example of dimension drawing. To see the latest dimension drawings and download 3D BIM objects in Autodesk Revit format please go to our website: [www.airmaster-as.com](http://www.airmaster-as.com)

## SCHEMATIC SKETCH

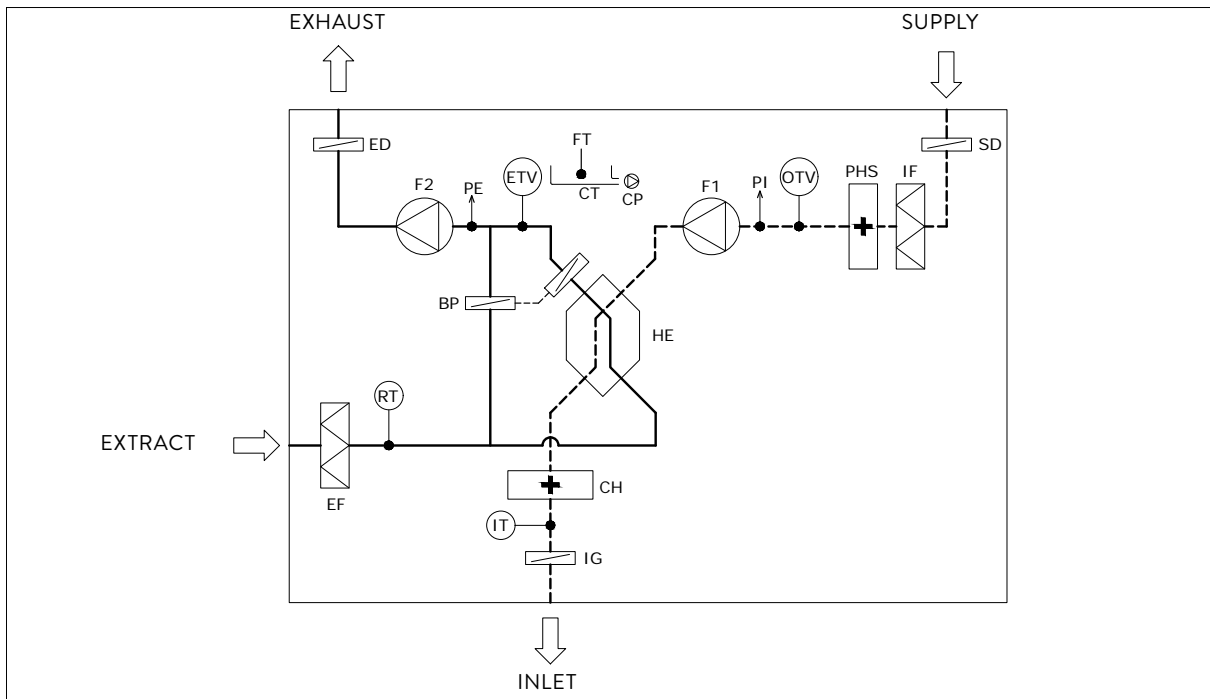

### NAME OF COMPONENT

BP	Bypass (motor driven)	ETV	Exhaust temperature sensor	IT	Inlet air temperature sensor
CH	Comfort heating surface (option)	FT	Float	OTV	Outside temperature sensor
CP	Condensate pump (option)	F1	Supply air fan	PE	Flow meter, extracted air
CT	Condensate tray	F2	Extract air fan	PHS	Preheating surface (option)
ED	Exhaust air damper (motor driven)	HE	Counterflow heat exchanger	PI	Flow meter, supply air
EF	Extract air filter	IF	Supply air filter	RT	Room temperature sensor
		IG	Inlet grille (motor driven)	SD	Supply air damper (motor driven)





**Decentralised ventilation gives freedom of choice. Airmaster's air handling units make adjustment easy and flexible to adapt ventilation to the room.**

# AM 900

The AM 900 air handling unit is available in two model types: mixed and displacement ventilation. The unit is designed to either act as a mixed or displacement air handling unit, depending on room configuration and use. The unit can be placed on the floor or discreetly between cupboards, as an integrated part of the room.

The AM 900 is ideal for larger rooms, such as classrooms, meeting rooms and open plan offices.



TECHNICAL DATA	FILTER CLASS	30 dB(A)	35 dB(A)
<b>Mixed</b>			
Maximum capacity	ePM <sub>10</sub> 75%	690 m <sup>3</sup> /h	830 m <sup>3</sup> /h
	ePM <sub>1</sub> 55%	669 m <sup>3</sup> /h	805 m <sup>3</sup> /h
	ePM <sub>1</sub> 80%	649 m <sup>3</sup> /h	780 m <sup>3</sup> /h
Throw length (0,2 m/s)		6 m at 690 m <sup>3</sup> /h	7,2 m at 830 m <sup>3</sup> /h
Maximum capacity	ePM <sub>10</sub> 75%	650 m <sup>3</sup> /h	800 m <sup>3</sup> /h
	ePM <sub>1</sub> 55%	631 m <sup>3</sup> /h	776 m <sup>3</sup> /h
	ePM <sub>1</sub> 80%	611 m <sup>3</sup> /h	752 m <sup>3</sup> /h
<b>Displacement ventilation</b>			
Adjacent zone (0,2 m/s)		Adjacent zone to outlet, approx. 1,2 m at 650 m <sup>3</sup> /h	Adjacent zone to outlet, approx. 1,5 m at 800 m <sup>3</sup> /h
Nominal current*		1,8 A	
Nominal power consumption*		240 W	
Electrical connection		1 x 230 V + N + PE / 50 Hz	
Duct connections		Ø315 mm	
Condensate drain		Ø4/6 mm	
Weight		180 kg	
Counterflow heat exchanger		3 x PET	
Supply air filter		ePM <sub>10</sub> 75%, ePM <sub>1</sub> 55% or ePM <sub>1</sub> 80%	
Extract air filter		ePM <sub>10</sub> 75%	
Colour, casing		Ral 9010 (white)	
Power cable		3 x 1,5 mm <sup>2</sup>	
Recommended fuse		13 A	
Leakage current		≤ 6 mA	
Dimensions (WxHxD)		Mixed: 800 x 2323 x 602 mm	
		Displ.: 800 x 2323 x 687 mm	
Minimum ceiling height		2490 mm	

\* At filter class, supply air/extract air: ePM<sub>10</sub> 75% / ePM<sub>10</sub> 75%

ELECTRIC HEATING SURFACE	PRE-HEATER	COMFORT HEATER
Heat output	1500 W	1050 W
Thermal circuit breaker, aut. reset	75°C	75°C
Thermal circuit breaker, man. reset	120°C	120°C

WATER HEATING SURFACE	COMFORT HEATER
Max. operating temperature	90°C
Max. operating pressure	10 bar
Heat output	2345 W*
Connection dimension	1/2" (DN 15)
Materials pipes/fins	copper/aluminium
Open/close time, motor valve	60 s

\* Capacity at: supply/return temperature 60/40°C, water volume 111 l/h

STANDARD AND OPTIONS	AM 900
Bypass	X
Electric preheater	●
Electric comfort heater	●
Water comfort heater	●
CO <sub>2</sub> sensor (built-in)	●
Condensate pump	●
Motor driven exhaust air damper	X
Motor driven supply air damper	X
Capacitive return for motorised damper	●
Counterflow heat exchanger (PET)	X
Energy meter	●

X: standard ●: option

# AM 900

CAPACITY with ePM<sub>10</sub> 75% / ePM<sub>10</sub> 75% filter - Mixed

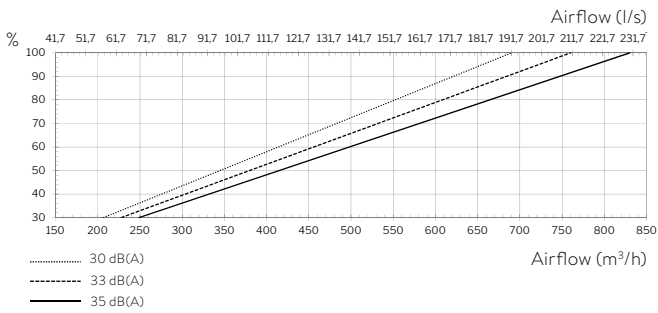

CAPACITY with ePM<sub>10</sub> 75% / ePM<sub>10</sub> 75% filter - Displacement

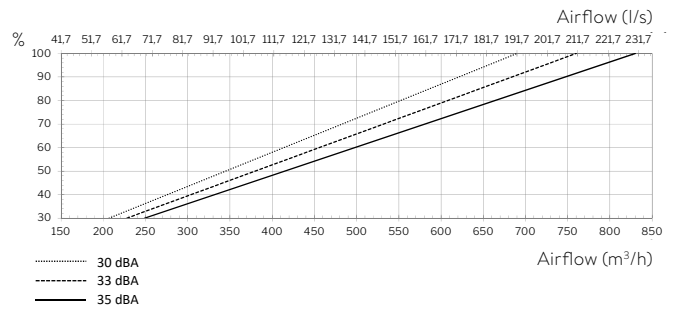

CAPACITY with ePM<sub>1</sub> 55% / ePM<sub>10</sub> 75% filter - Mixed

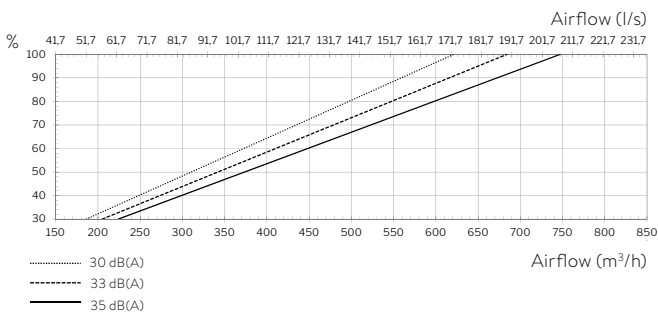

CAPACITY with ePM<sub>1</sub> 55% / ePM<sub>10</sub> 75% filter - Displacement

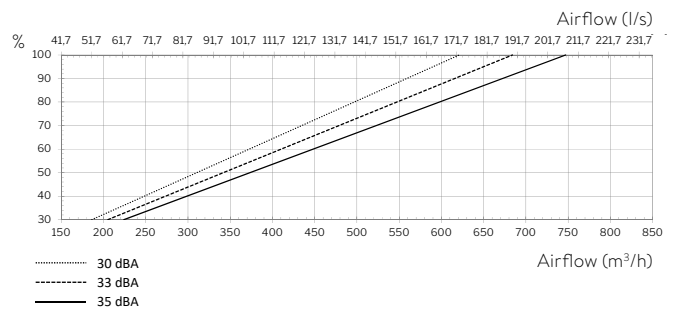

CAPACITY with ePM<sub>1</sub> 80% / ePM<sub>10</sub> 75% filter - Mixed

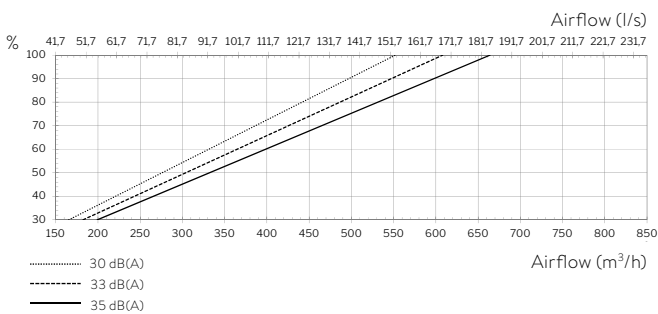

CAPACITY with ePM<sub>1</sub> 80% / ePM<sub>10</sub> 75% filter - Displacement

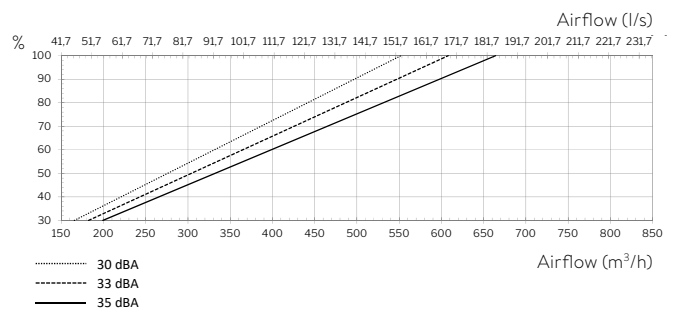

TEMPERATURE EFFICIENCY, ACC. TO EN 308:1997

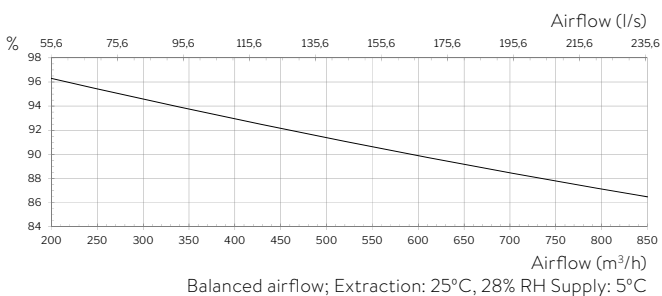

# AM 900

## SFP

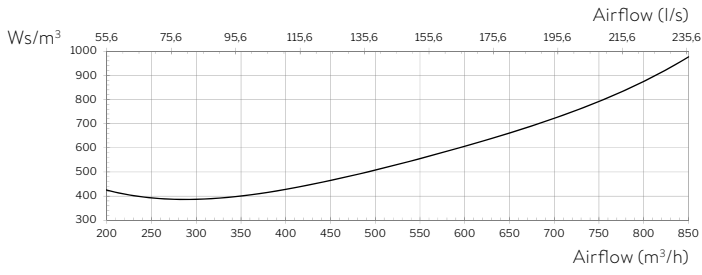

## POWER CONSUMPTION

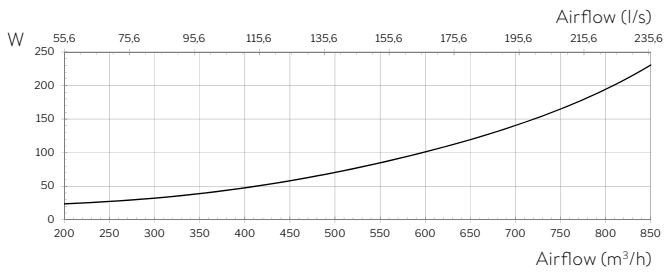

## EXTERNAL PRESSURE LOSS

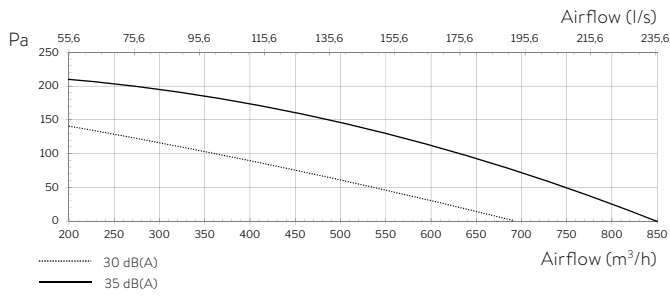

## SOUND PRESSURE

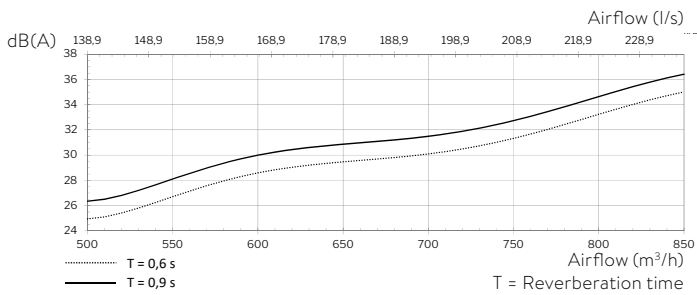

# AM 900

## THROW LENGTH - MIXED

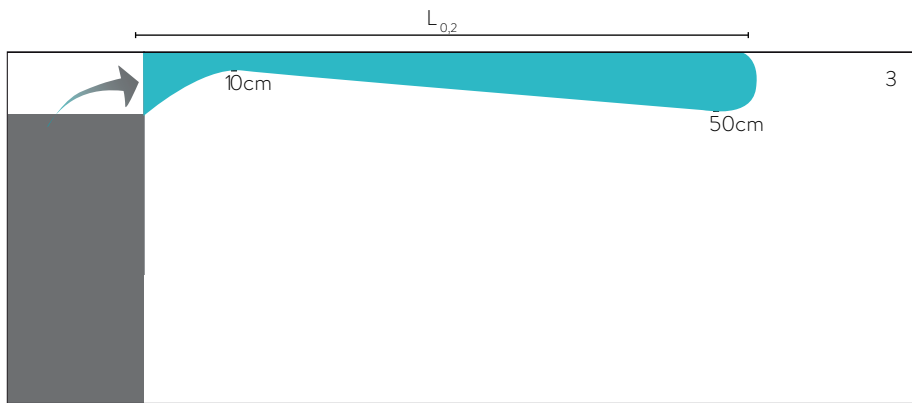
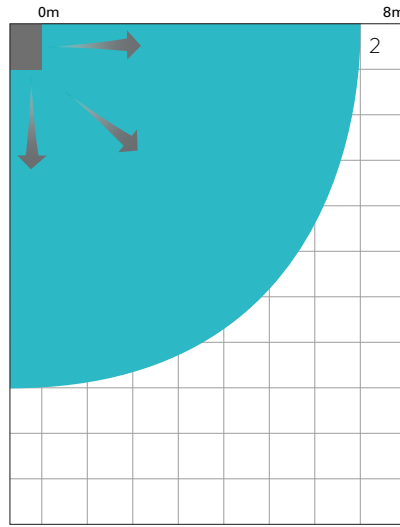
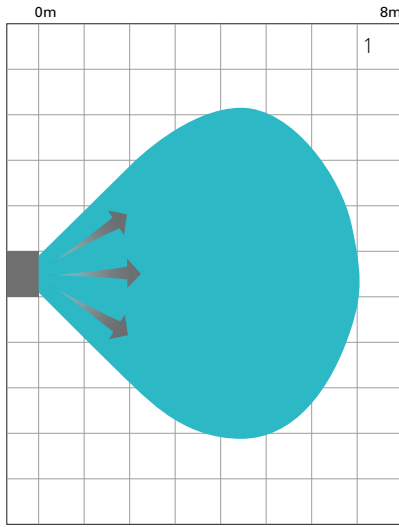

Throw length illustrated for volume flow rate 830 m<sup>3</sup>/h. At other volume flow rates the throw can be extrapolated:  
 $L_2 = L_1 \times q_2 / q_1$

The AM 900 unit spreads an air stream below the ceiling depending on the given flow rate.

Blue shading in the illustration indicates spread pattern and throw.

1. Spread pattern seen from above, symmetric inlet (default).
2. Spread pattern seen from above, asymmetric inlet.
3. Spread pattern seen from the side.

Throw length and spread of the supply air in the room can be adjusted to the geometry of the room by adjusting the inlet opening with a pair of pliers (see operator's manual).

## ADJACENT ZONE - DISPLACEMENT

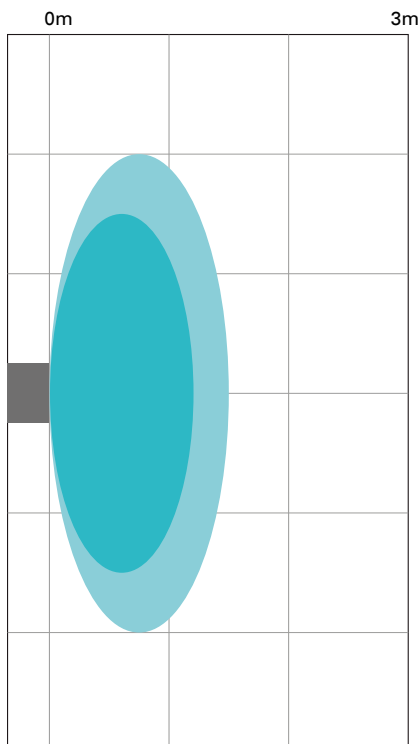

The result applies to an undertemperature of the inlet air of 3-5°C.

- 650m<sup>3</sup>/h
- 800m<sup>3</sup>/h

### Notes regarding ceiling height

The AM 900 will fit into a room with minimum ceiling height of 2,49 m. The illustrated throw will manifest itself in these circumstances.

The AM 900 will also work with larger ceiling heights, up to 4,50 m has been tested. Height above 2.50 m should be subtracted from the length of the throw.

# AM 900

SCHEMATIC SKETCH - MIXED

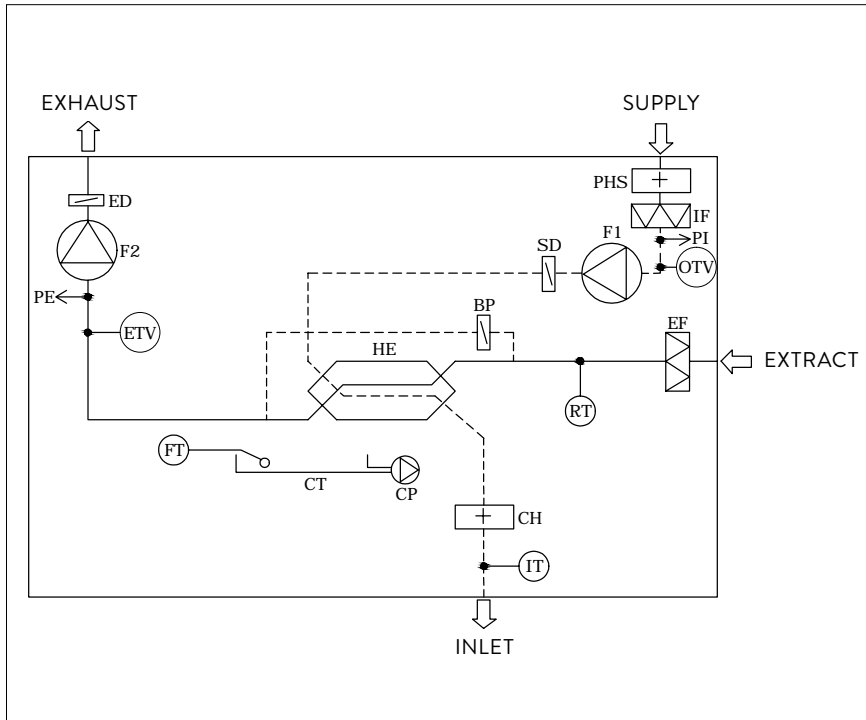

**NAME OF COMPONENT**

- BP Bypass (motor driven)
- CH Comfort heater (option)
- CP Condensate pump (option)
- CT Condensate tray
- ED Exhaust air damper (motor driven)
- EF Extract air filter
- ETV Exhaust temperature sensor
- FT Float
- F1 Supply air fan
- F2 Extract air fan
- HE Counterflow heat exchanger
- IF Supply air filter
- IT Inlet air temperature sensor
- OTV Outside temperature sensor
- PE Flow meter, return air
- PHS Preheating surface (option)
- PI Flow meter, supply air
- RT Room temperature sensor
- SD Supply air damper (motor driven)

SCHEMATIC SKETCH - DISPLACEMENT

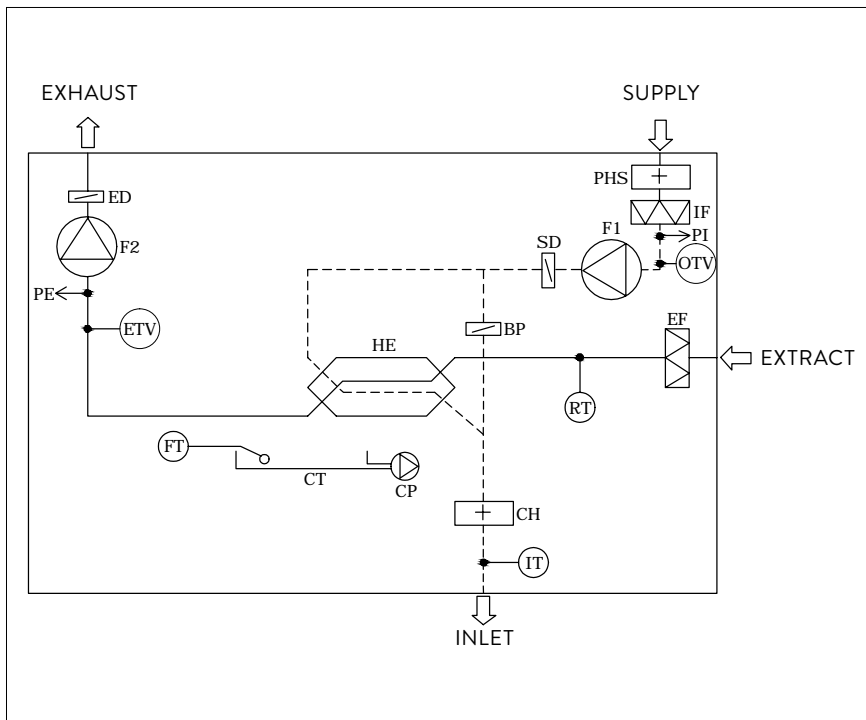

**NAME OF COMPONENT**

- BP Bypass (motor driven)
- CH Comfort heater (option)
- CP Condensate pump (option)
- CT Condensate tray
- ED Exhaust air damper (motor driven)
- EF Extract air filter
- ETV Exhaust temperature sensor
- FT Float
- F1 Supply air fan
- F2 Extract air fan
- HE Counterflow heat exchanger
- IF Supply air filter
- IT Inlet air temperature sensor
- OTV Outside temperature sensor
- PE Flow meter, return air
- PHS Preheating surface (option)
- PI Flow meter, supply air
- RT Room temperature sensor
- SD Supply air damper (motor driven)



# AM 900

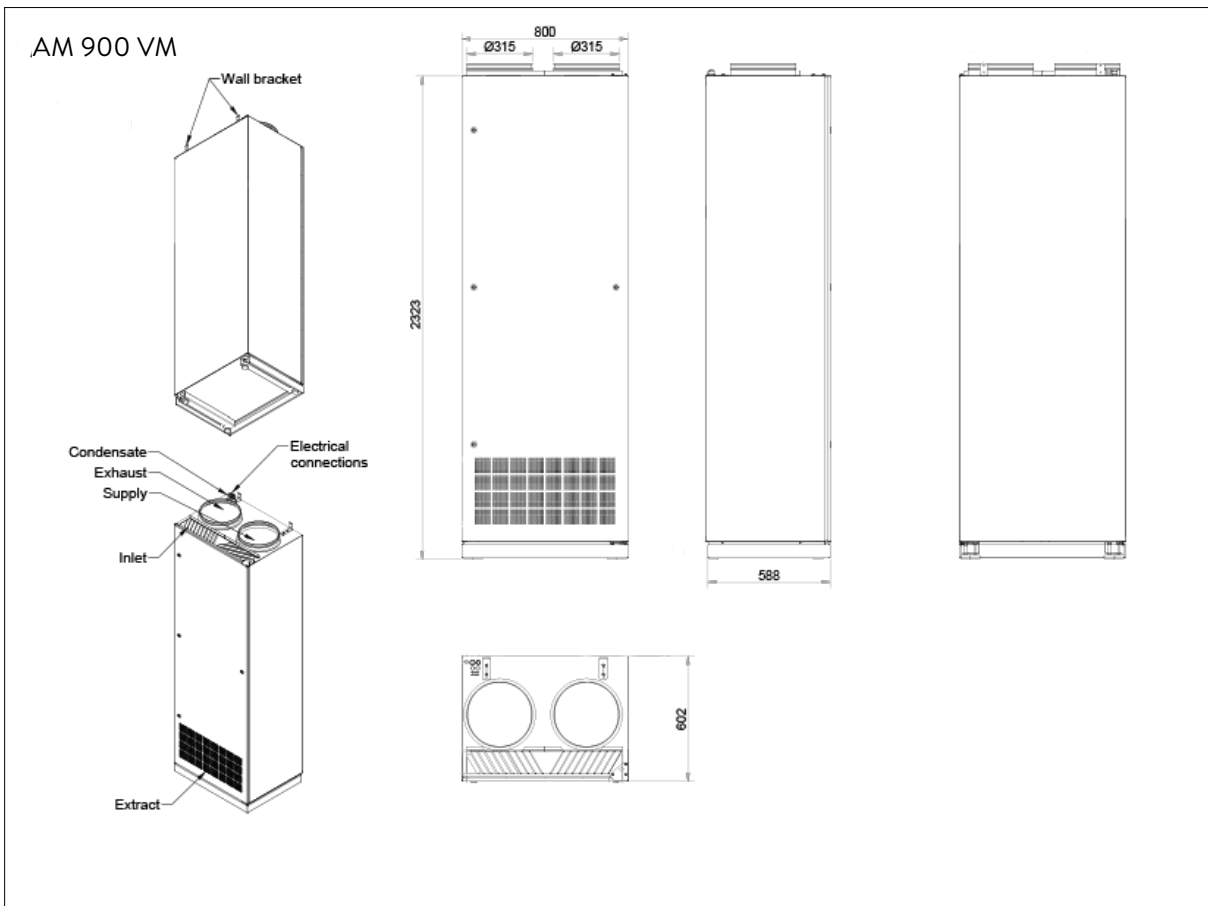
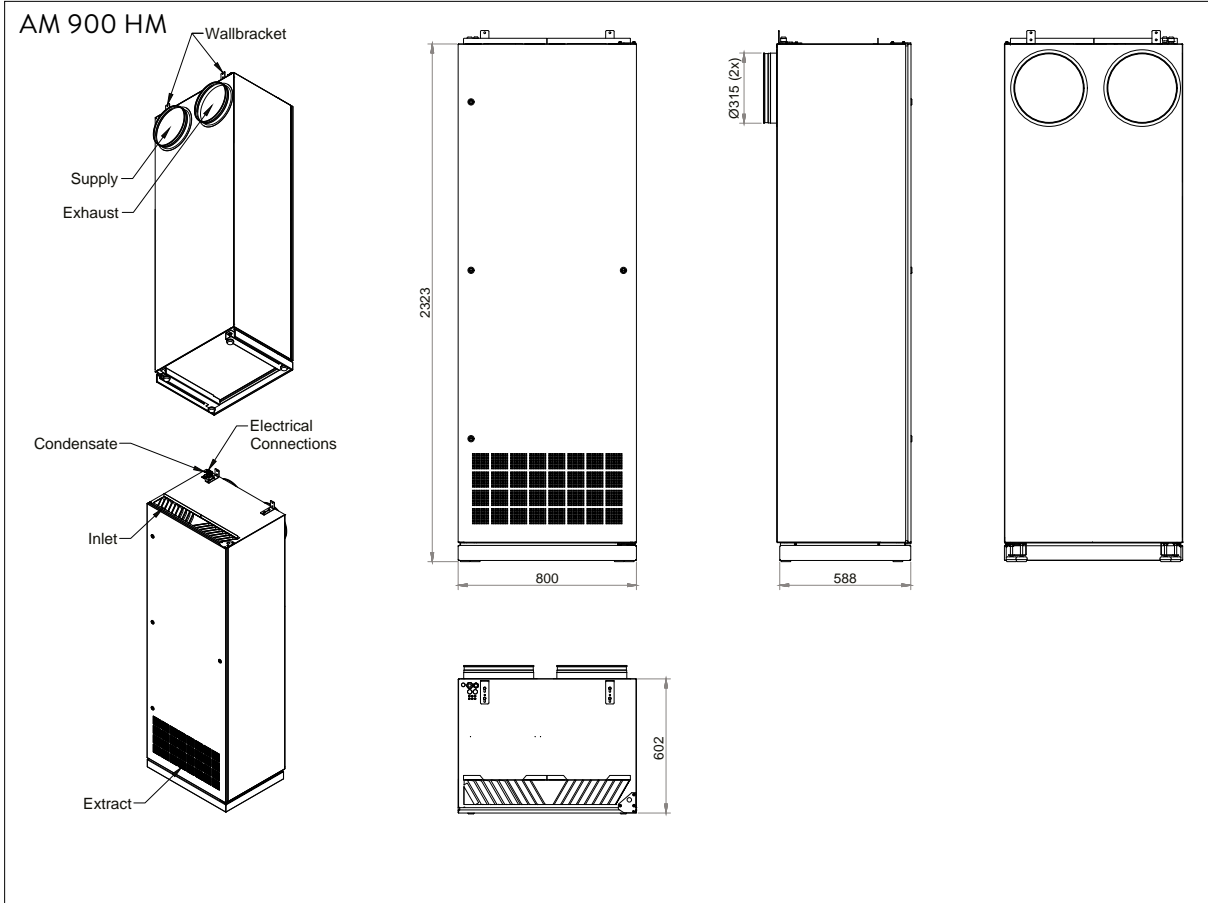





**By choosing Airmaster  
you choose an advanced  
and responsible solution.**

# AM 1200

Featuring function and design. Ventilation should not always just be a technical necessity. It can also play a part in the function of a room.

The AM 1200 is a concept within decentralised ventilation which combines fresh air with elegant design, which can be used for a lot more than you might believe.

The AM 1200 is a floor-standing unit, available in horizontal and vertical models. It can be mounted against a wall (right/left variant) or freestanding (central variant).

Different design panels mean the front can be used as a notice board, mirror or whiteboard for example.



TECHNICAL DATA	FILTER CLASS	30 dB(A)	35 dB(A)
Maximum capacity Horizontal model, Ø400 mm right / left:	ePM <sub>10</sub> 75%	930 m <sup>3</sup> /h	1180 m <sup>3</sup> /h
	ePM <sub>1</sub> 55%	837 m <sup>3</sup> /h	1062 m <sup>3</sup> /h
	ePM <sub>1</sub> 80%	744 m <sup>3</sup> /h	944 m <sup>3</sup> /h
Maximum capacity Horizontal model, Ø400 mm center:	ePM <sub>10</sub> 75%	1050 m <sup>3</sup> /h	1310 m <sup>3</sup> /h
	ePM <sub>1</sub> 55%	945 m <sup>3</sup> /h	1179 m <sup>3</sup> /h
	ePM <sub>1</sub> 80%	840 m <sup>3</sup> /h	1048 m <sup>3</sup> /h
Maximum capacity Vertical model, Ø400 mm right / left:	ePM <sub>10</sub> 75%	870 m <sup>3</sup> /h	1130 m <sup>3</sup> /h
	ePM <sub>1</sub> 55%	783 m <sup>3</sup> /h	1017 m <sup>3</sup> /h
	ePM <sub>1</sub> 80%	696 m <sup>3</sup> /h	904 m <sup>3</sup> /h
Maximum capacity Vertical model, Ø400 mm center:	ePM <sub>10</sub> 75%	980 m <sup>3</sup> /h	1260 m <sup>3</sup> /h
	ePM <sub>1</sub> 55%	882 m <sup>3</sup> /h	1134 m <sup>3</sup> /h
	ePM <sub>1</sub> 80%	784 m <sup>3</sup> /h	1008 m <sup>3</sup> /h
Maximum capacity Vertical model, Ø315 mm right / left:**	ePM <sub>10</sub> 75%	820 m <sup>3</sup> /h	1060 m <sup>3</sup> /h
	ePM <sub>1</sub> 55%	738 m <sup>3</sup> /h	954 m <sup>3</sup> /h
	ePM <sub>1</sub> 80%	656 m <sup>3</sup> /h	848 m <sup>3</sup> /h
Maximum capacity Vertical model, Ø315 mm center:**	ePM <sub>10</sub> 75%	920 m <sup>3</sup> /h	1170 m <sup>3</sup> /h
	ePM <sub>1</sub> 55%	828 m <sup>3</sup> /h	1053 m <sup>3</sup> /h
	ePM <sub>1</sub> 80%	736 m <sup>3</sup> /h	936 m <sup>3</sup> /h
Throw length (0,2 m/s) - center	ePM <sub>10</sub> 75%	min. 3 m at 1000 m <sup>3</sup> /h	
	ePM <sub>1</sub> 55%	max. 6,5 m at 1000 m <sup>3</sup> /h	
	ePM <sub>1</sub> 80%	min. 4 m at 1300 m <sup>3</sup> /h	
Throw length (0,2 m/s) - right / left	ePM <sub>10</sub> 75%	max. 8 m at 1300 m <sup>3</sup> /h	
	ePM <sub>1</sub> 55%	min. 4 m at 1000 m <sup>3</sup> /h	
	ePM <sub>1</sub> 80%	max. 9 m at 1000 m <sup>3</sup> /h	
Nominal current*		min. 5,5 m at 1300 m <sup>3</sup> /h	
Nominal power consumption*		max. 11 m at 1300 m <sup>3</sup> /h	
Electrical connection		1,4 A	
Duct connections		254 W	
Condensate drain		3 x 400 V + N + PE / 50 Hz	
Weight		Ø400 mm	
		Ø16 mm	
Counterflow heat exchanger		Right/left variant: 545 kg	
Supply air filter		Center variant: 630 kg	
Extract air filter		4 x Aluminium	
Recommended fuse		ePM <sub>10</sub> 75%, ePM <sub>1</sub> 55% or ePM <sub>1</sub> 80%	
Leakage current		ePM <sub>10</sub> 75%	
Dimensions (WxHxD)		3x13 A	
		≤ 9 mA	
		Horizontal: 496 x 2098 x 2427 mm	
		Vertical: 496 x 2406 x 2427 mm	

\* At filter class, supply air/extract air: ePM<sub>10</sub> 75% / ePM<sub>10</sub> 75%

\*\* With roof cap module

# AM 1200

ELECTRIC HEATING SURFACE	PREHEATING FUNCTION	COMFORT HEATING FUNCTION
Heat output	2500 W	1670 W
Thermal circuit breaker, aut. reset	75°C	75°C
Thermal circuit breaker, man. reset	120°C	120°C

WATER HEATING SURFACE	COMFORT HEATING FUNCTION
Max. operating temperature	90°C
Max. operating pressure	10 bar
Heat output	2454 W*
Connection dimension	1/2" (DN 15)
Materials pipes/fins	copper/aluminium
Open/close time, motor valve	60 s

\* Capacity at: supply/return temperature 60/40°C, water volume 107 l/h

STANDARD AND OPTIONS	AM 1200 V
Bypass	X
Electric preheating surface	●
Electric comfort heating surface	●
Water heating surface	●
CO <sub>2</sub> sensor (built-in)	●
Hygrostat	●
Condensate pump	●
Spring-return motor on main air damper (supply and exhaust)	X
Counterflow heat exchanger (aluminium)	X
Energy meter	●

X : standard    ● : option

## THROW LENGTH

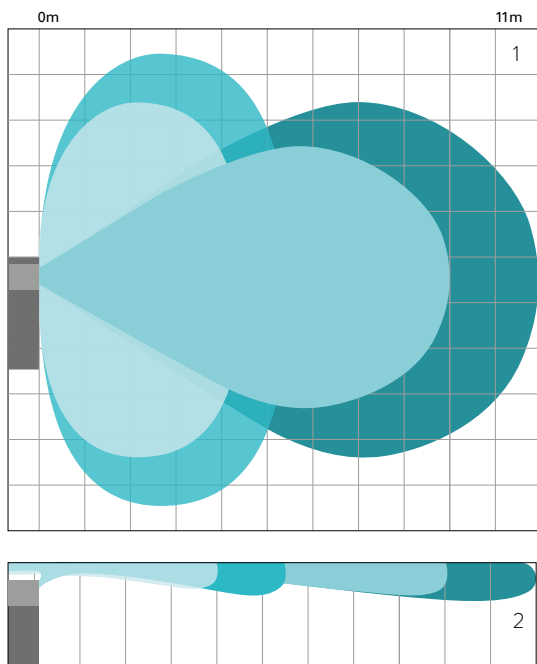

- 1300 m<sup>3</sup>/h**
  - max throw length
  - min throw length
- 1000 m<sup>3</sup>/h**
  - max throw length
  - min throw length

The AM 1200 unit spreads an air stream in different directions, depending on the given airflow. This can be seen in the illustration on the left, in which the blue shading indicates throw length the different airflows.

<sup>1</sup> Throw length seen from above

<sup>2</sup> Throw length seen from the side

# AM 1200

## VARIANTS

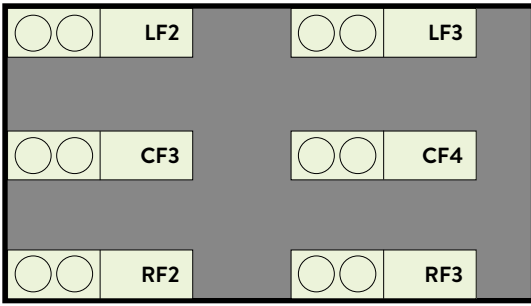

- AM 1200 VRF2 (right, with 2 open sides)
- AM 1200 VRF3 (right, with 3 open sides)
- AM 1200 VCF3 (centre, with 3 open sides)
- AM 1200 VCF4 (centre, with 4 open sides)
- AM 1200 VLF2 (left, with 2 open sides)
- AM 1200 VLF3 (left, with 3 open sides)

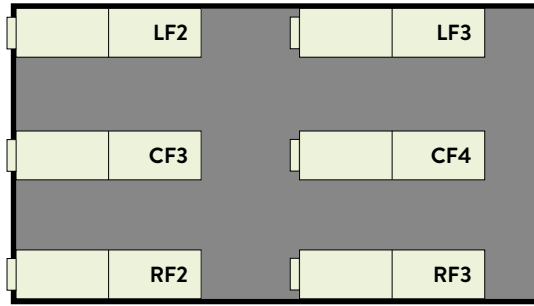

- AM 1200 HRF2 (right, with 2 open sides)
- AM 1200 HRF3 (right, with 3 open sides)
- AM 1200 HCF3 (centre, with 3 open sides)
- AM 1200 HCF4 (centre, with 4 open sides)
- AM 1200 HLF2 (left, with 2 open sides)
- AM 1200 HLF3 (left, with 3 open sides)

DESIGN PANELS	COLOUR	SIZE
MDF	Painted (standard colours)	1200 x 1000
MDF with whiteboard laminate*	White	1200 x 1000
MDF with noticeboard surface	Black	1200 x 1000
Mirror glued on MDF	Mirror	1200 x 1000

\* We are offering the best quality of whiteboards with a surface of ceramic enamel. Ceramic enamel forms a completely closed surface and is therefore also extremely easy to clean.



### Colour options

Painted MDF boards are supplied in the following 8 standard colours. Other RAL colours are available at extra cost.

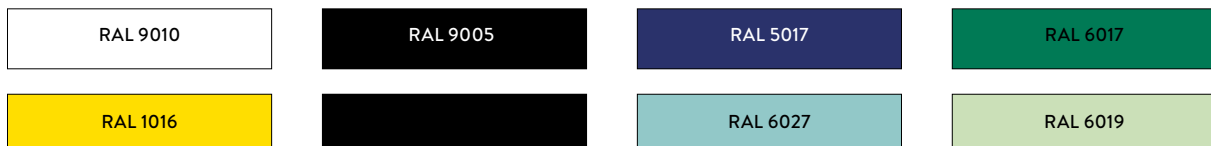

# AM 1200 H

**H - L/R** CAPACITY with ePM<sub>10</sub> 75% / ePM<sub>10</sub> 75% filter

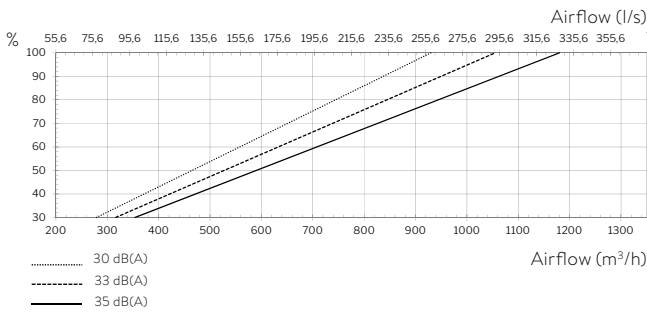

**H - C** CAPACITY with ePM<sub>10</sub> 75% / ePM<sub>10</sub> 75% filter

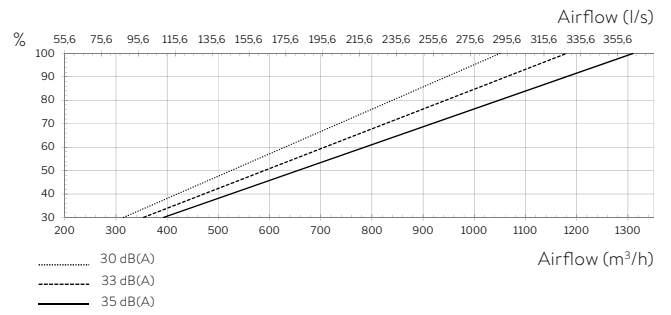

**H - L/R** CAPACITY with ePM<sub>1</sub> 55% / ePM<sub>10</sub> 75% filter

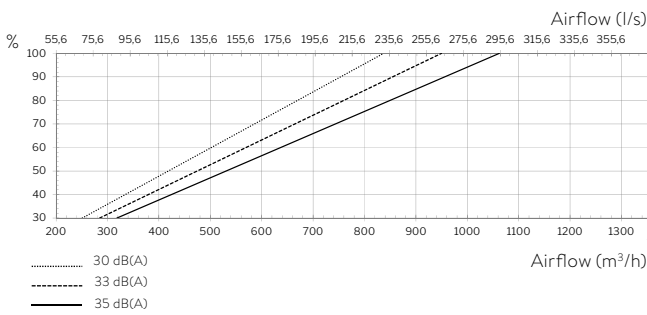

**H - C** CAPACITY with ePM<sub>1</sub> 55% / ePM<sub>10</sub> 75% filter

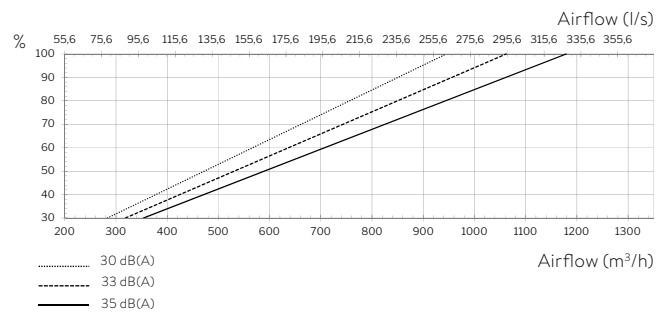

**H - L/R** CAPACITY with ePM<sub>1</sub> 80% / ePM<sub>10</sub> 75% filter

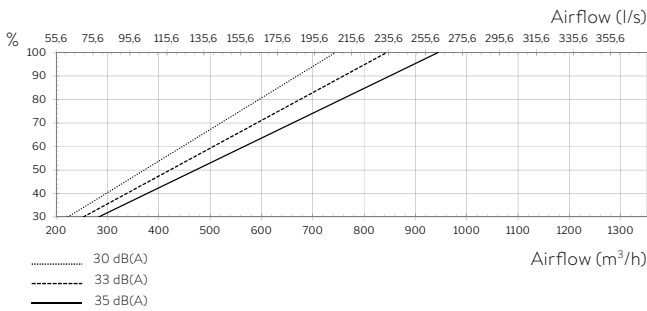

**H - C** CAPACITY with ePM<sub>1</sub> 80% / ePM<sub>10</sub> 75% filter

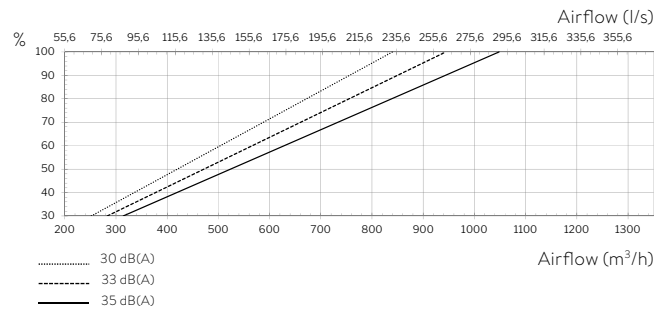

# AM 1200 H

## SFP

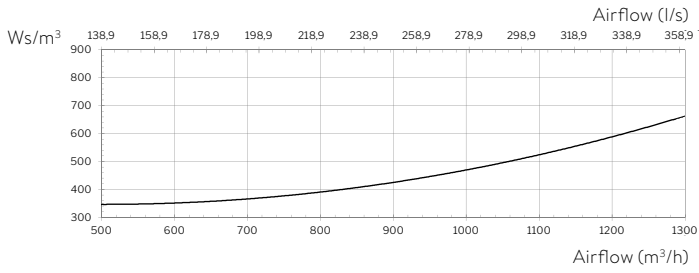

## POWER CONSUMPTION

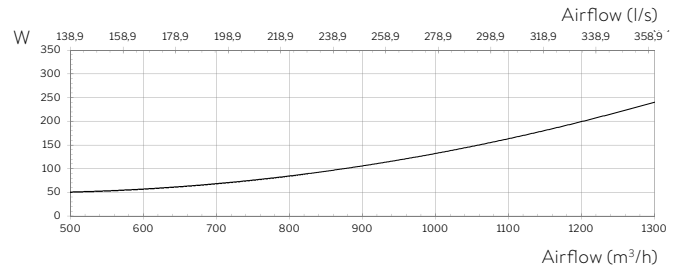

## TEMPERATURE EFFICIENCY, ACC. TO EN 308:1997

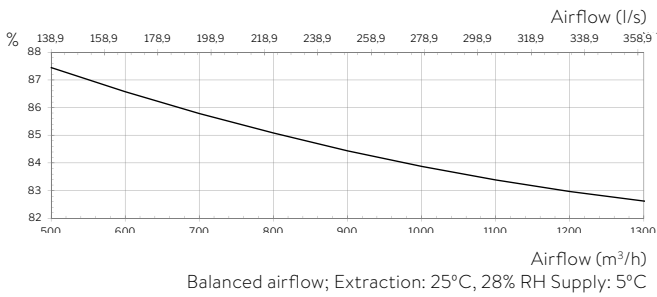

## SOUND PRESSURE

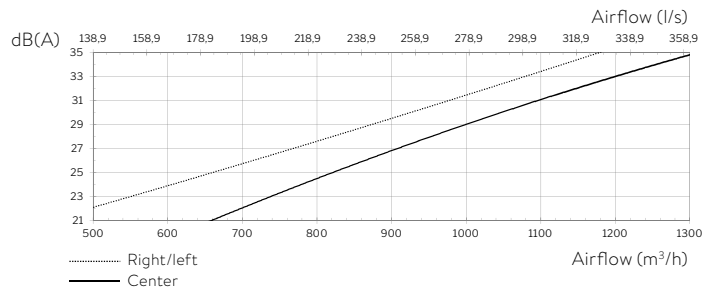

## EXTERNAL PRESSURE LOSS - SUPPLY AIR

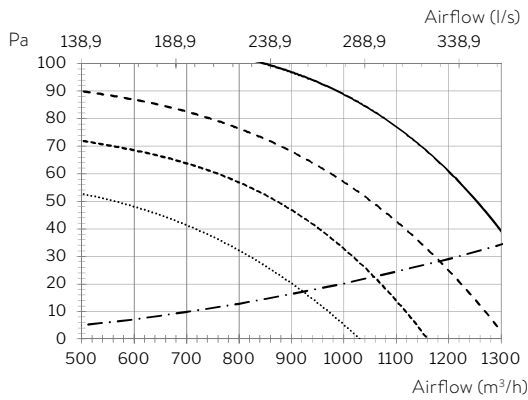

## EXTERNAL PRESSURE LOSS - EXTRACT AIR

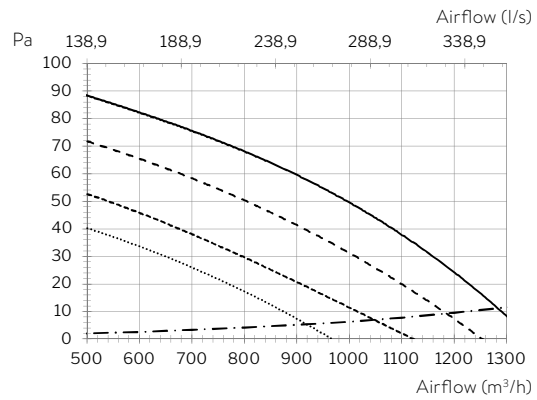

- Center, 35 dB(A), ePM<sub>10</sub> 75% filter
- - - Right/left, 35 dB(A), ePM<sub>10</sub> 75% filter
- · - Center, 30 dB(A), ePM<sub>10</sub> 75% filter
- Right/left, 30 dB(A), ePM<sub>10</sub> 75% filter
- - - Facade grille Ø400

- Center, 35 dB(A), ePM<sub>10</sub> 75% filter
- - - Right/left, 35 dB(A), ePM<sub>10</sub> 75% filter
- · - Center, 30 dB(A), ePM<sub>10</sub> 75% filter
- Right/left, 30 dB(A), ePM<sub>10</sub> 75% filter
- - - Facade grille Ø400



# AM 1200 V

**V - L/R** CAPACITY with ePM<sub>10</sub> 75% / ePM<sub>10</sub> 75% filter

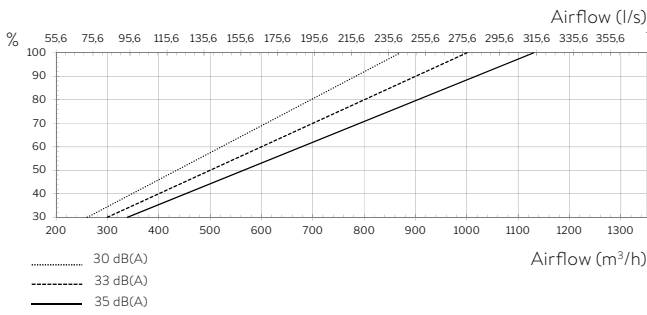

**V - C** CAPACITY with ePM<sub>10</sub> 75% / ePM<sub>10</sub> 75% filter

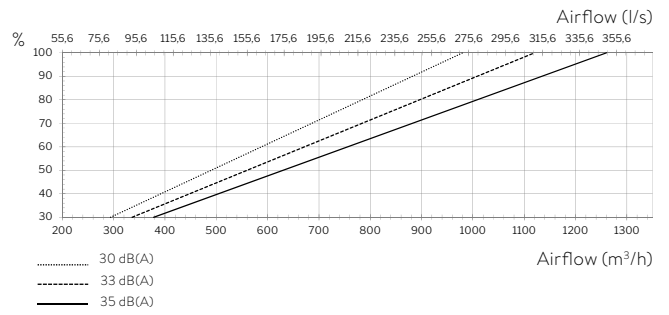

**V - L/R** CAPACITY with ePM<sub>1</sub> 55% / ePM<sub>10</sub> 75% filter

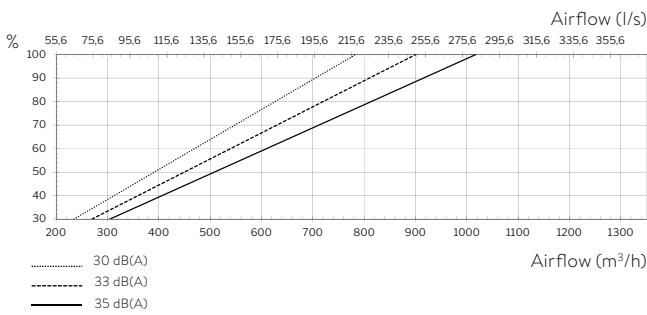

**V - C** CAPACITY with ePM<sub>1</sub> 55% / ePM<sub>10</sub> 75% filter

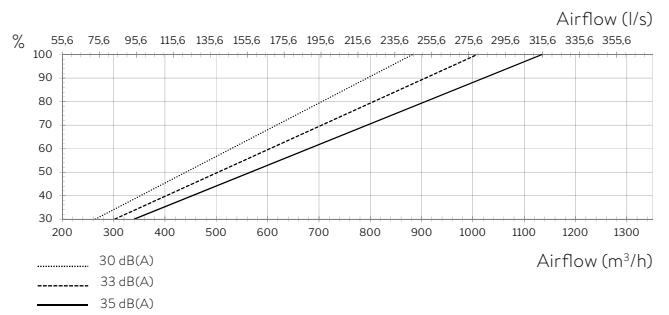

**V - L/R** CAPACITY with ePM<sub>1</sub> 80% / ePM<sub>10</sub> 75% filter

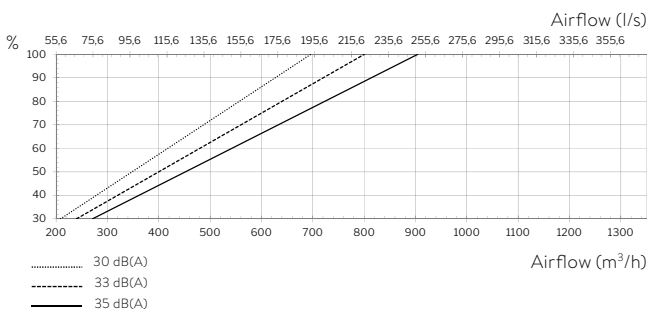

**V - C** CAPACITY with ePM<sub>1</sub> 80% / ePM<sub>10</sub> 75% filter

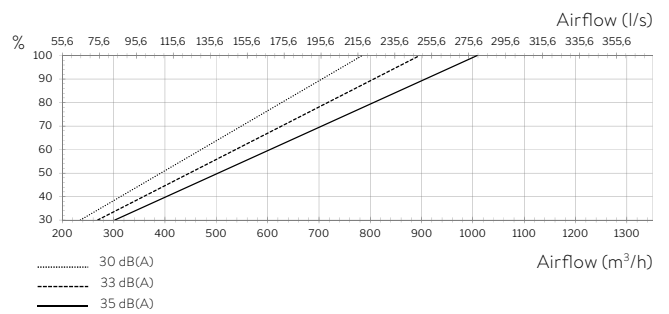

# AM 1200 V

## SFP

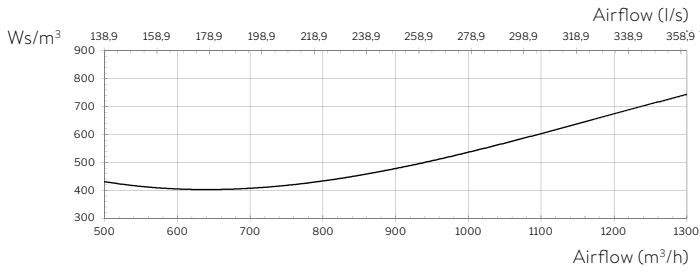

## POWER CONSUMPTION

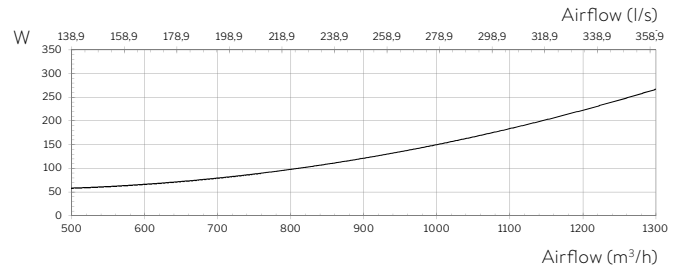

## TEMPERATURE EFFICIENCY, ACC. TO EN 308:1997

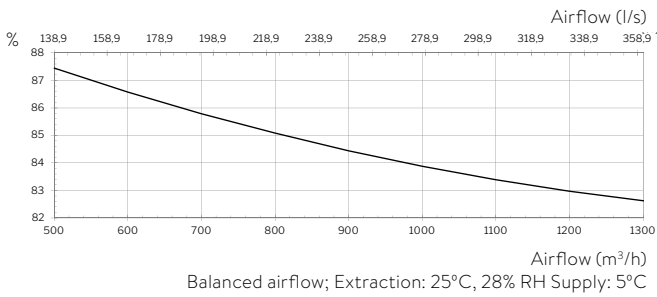

## SOUND PRESSURE

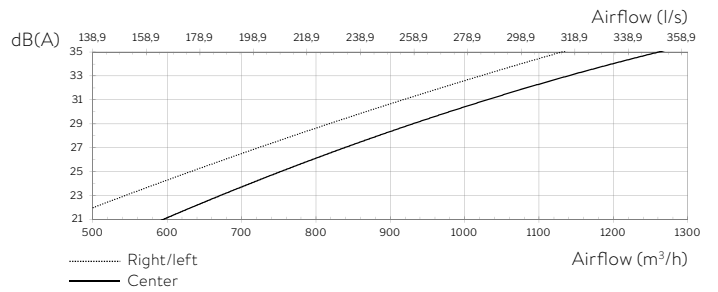

## EXTERNAL PRESSURE LOSS - SUPPLY AIR

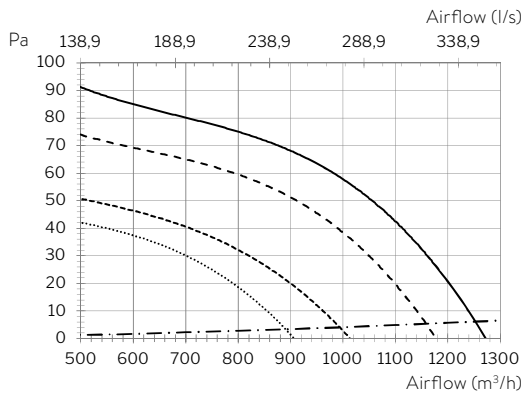

- Center, 35 dB(A), ePM<sub>10</sub> 75% filter
- - - Right/left, 35 dB(A), ePM<sub>10</sub> 75% filter
- - - Center, 30 dB(A), ePM<sub>10</sub> 75% filter
- ..... Right/left, 30 dB(A), ePM<sub>10</sub> 75% filter
- · - · - Roof cap module Ø400

## EXTERNAL PRESSURE LOSS - EXTRACT AIR

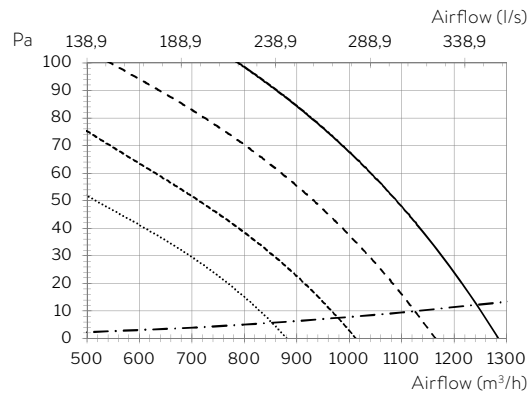

- Center, 35 dB(A), ePM<sub>10</sub> 75% filter
- - - Right/left, 35 dB(A), ePM<sub>10</sub> 75% filter
- - - Center, 30 dB(A), ePM<sub>10</sub> 75% filter
- ..... Right/left, 30 dB(A), ePM<sub>10</sub> 75% filter
- · - · - Roof cap module Ø400

# AM 1200 V Ø315

**V - L/R Ø315** CAPACITY with ePM<sub>10</sub> 75% / ePM<sub>10</sub> 75% filter

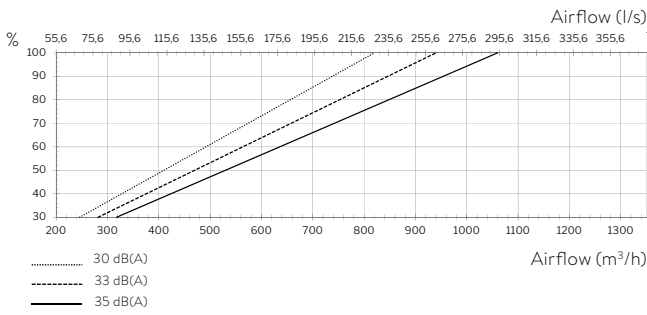

**V - C Ø315** CAPACITY with ePM<sub>10</sub> 75% / ePM<sub>10</sub> 75% filter

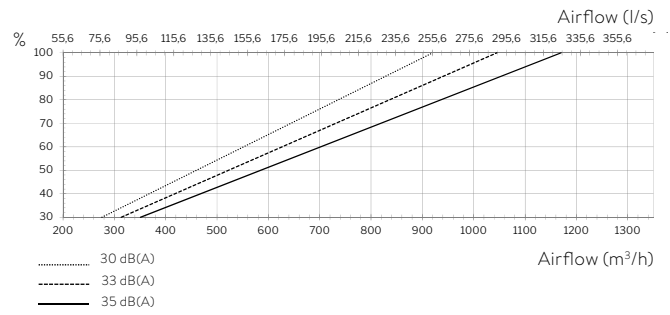

**V - L/R Ø315** CAPACITY with ePM<sub>1</sub> 55% / ePM<sub>10</sub> 75% filter

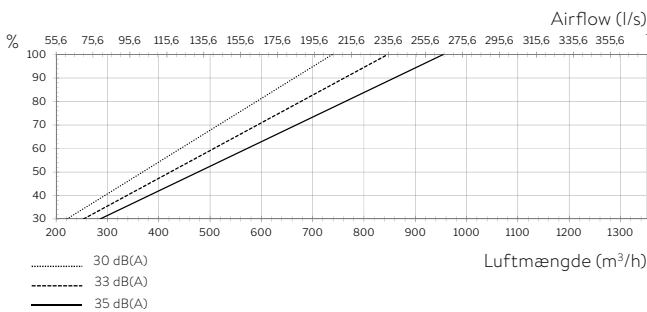

**V - C Ø315** CAPACITY with ePM<sub>1</sub> 55% / ePM<sub>10</sub> 75% filter

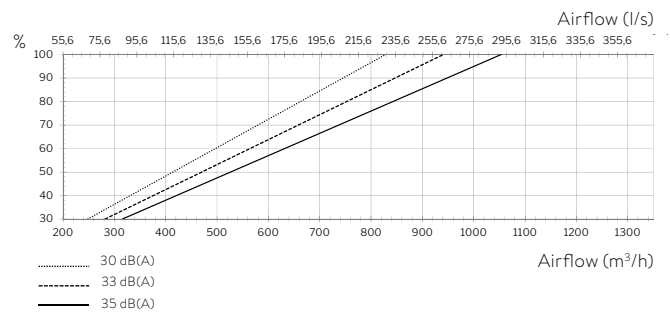

**V - L/R Ø315** CAPACITY with ePM<sub>1</sub> 80% / ePM<sub>10</sub> 75% filter

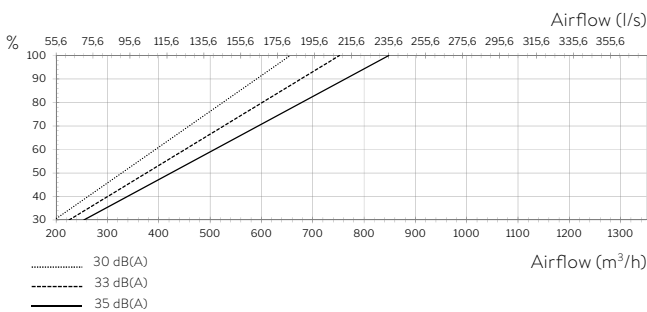

**V - C Ø315** CAPACITY with ePM<sub>1</sub> 80% / ePM<sub>10</sub> 75% filter

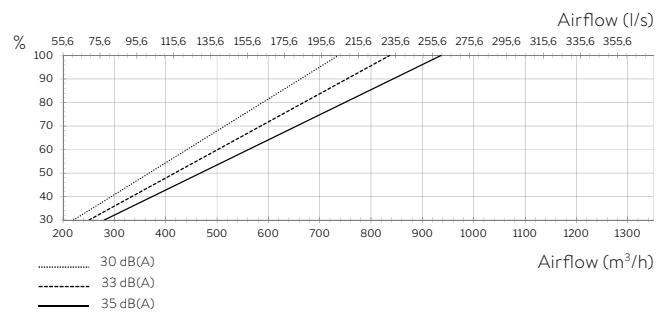

# AM 1200 V Ø315

## SFP

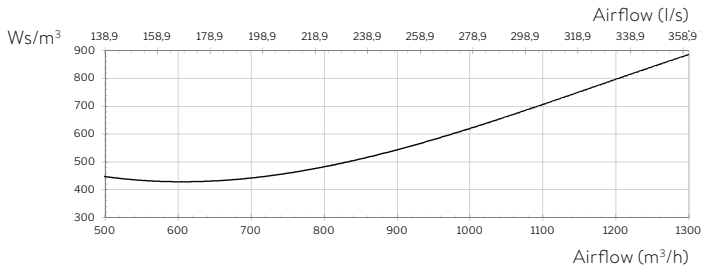

## POWER CONSUMPTION

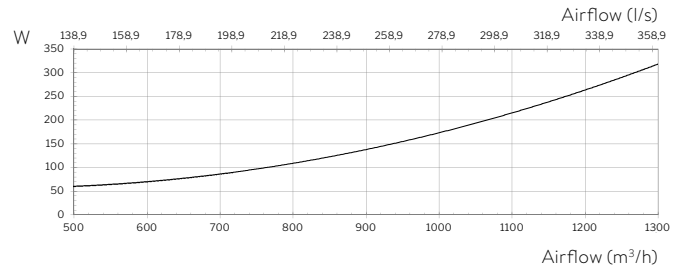

## TEMPERATURE EFFICIENCY, ACC. TO EN 308:1997

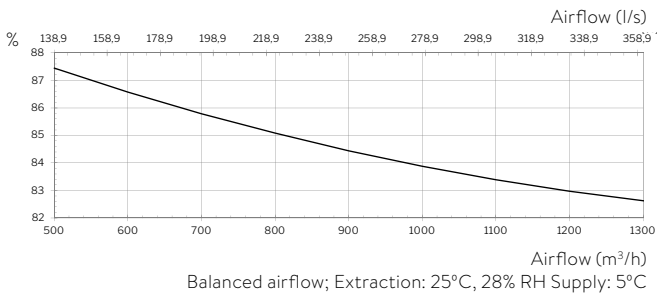

## SOUND PRESSURE

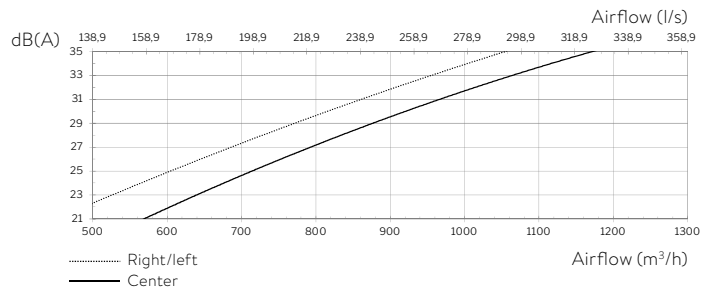

## EXTERNAL PRESSURE LOSS - SUPPLY AIR

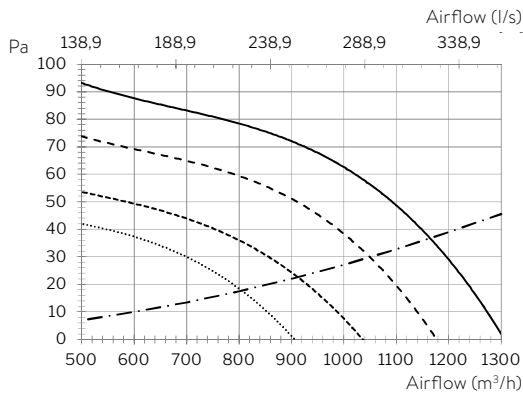

- Center, 35 dB(A), ePM<sub>10</sub> 75% filter
- - - Right/left, 35 dB(A), ePM<sub>10</sub> 75% filter
- · - · Center, 30 dB(A), ePM<sub>10</sub> 75% filter
- ..... Right/left, 30 dB(A), ePM<sub>10</sub> 75% filter
- · - · Roof cap module Ø315

## EXTERNAL PRESSURE LOSS - EXTRACT AIR

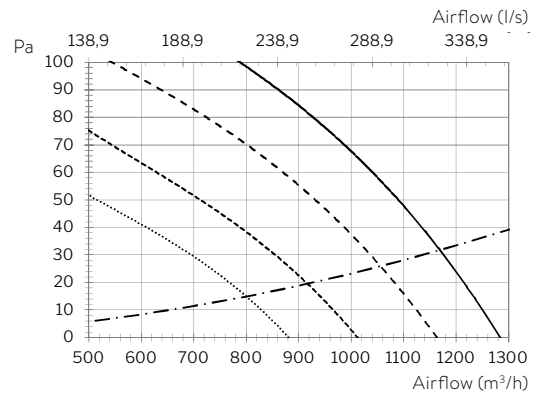

- Center, 35 dB(A), ePM<sub>10</sub> 75% filter
- - - Right/left, 35 dB(A), ePM<sub>10</sub> 75% filter
- · - · Center, 30 dB(A), ePM<sub>10</sub> 75% filter
- ..... Right/left, 30 dB(A), ePM<sub>10</sub> 75% filter
- · - · Roof cap module Ø315

# AM 1200

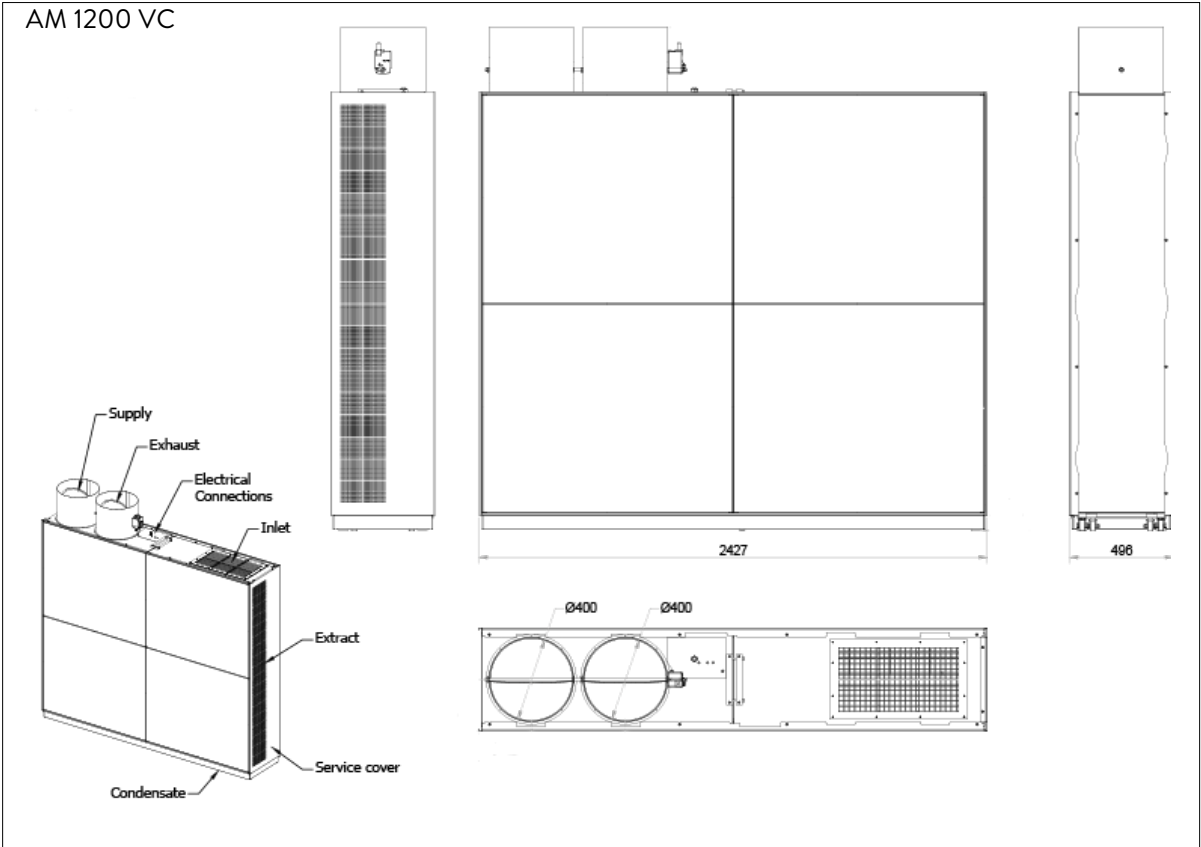
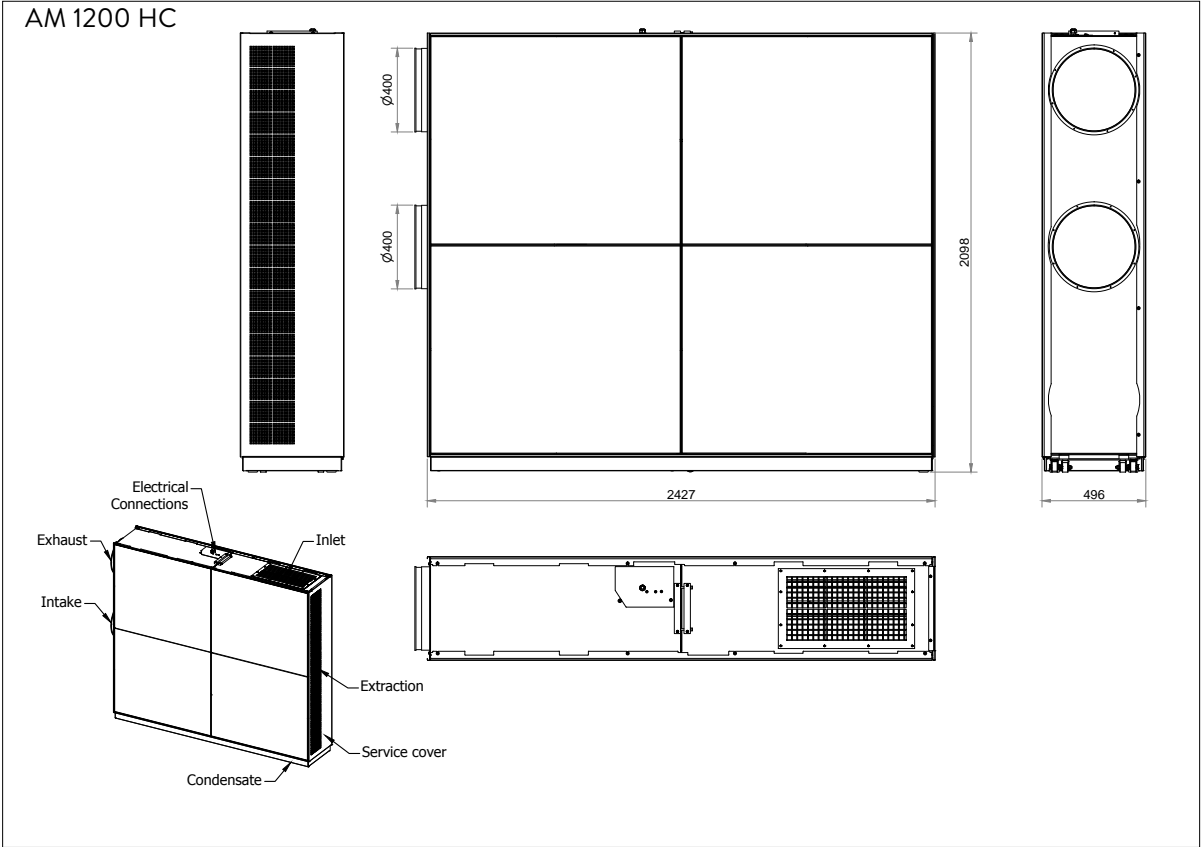

Example of dimension drawing. To see the latest dimension drawings and download 3D BIM objects in Autodesk Revit format please go to our website: [www.airmaster-as.com](http://www.airmaster-as.com)

# AM 1200

## SCHEMATIC SKETCH

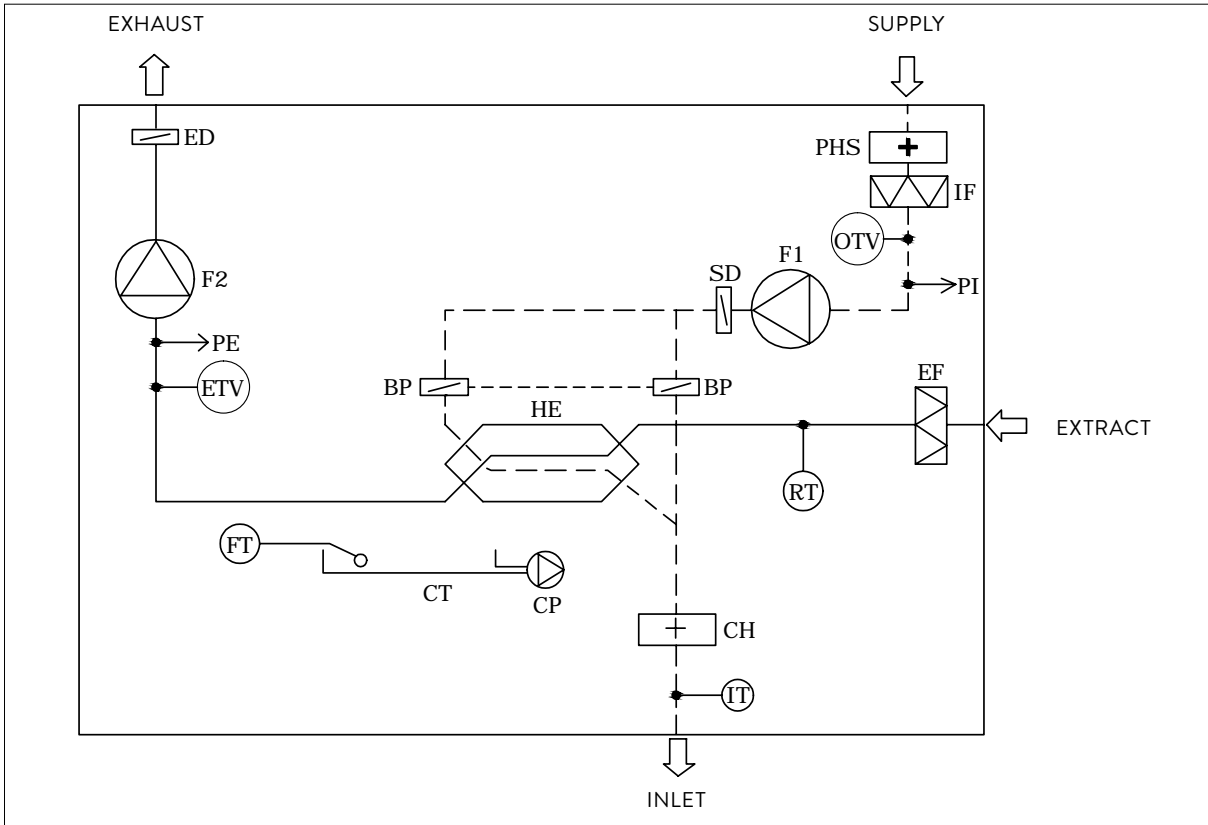

### NAME OF COMPONENT

BP	Bypass (motor driven)	EF	Extract air filter	OTV	Outside temperature sensor
CH	Comfort heating surface (option)	ETV	Exhaust temperature sensor	PE	Flow meter, return air
CP	Condensate pump (option)	FT	Float	PHS	Preheating surface (option)
CT	Condensate tray	F1	Supply air fan	PI	Flow meter, supply air
ED	Exhaust air damper (motor driven, spring return)	F2	Extract air fan	RT	Room temperature sensor
		HE	Counterflow heat exchanger	SD	Supply air damper (motor driven, spring return)
		IF	Supply air filter		
		IT	Inlet air temperature sensor		

**Workouts affect the air quality of the room.  
An effective air change, without traits,  
ensures optimal training conditions.**



# DV 1000

The DV 1000 is a compact, high pressure unit with low SFP value.

It is available in two variants - hinged (**H**) or sliding doors (**S**). The option makes it suitable for either vertical or horizontal opening, depending on the type of ceiling and space available.



TECHNICAL DATA	FILTERCLASS	
Nominal capacity	ePM <sub>10</sub> 75%	1000 m <sup>3</sup> /h
	ePM <sub>1</sub> 55%	950 m <sup>3</sup> /h
	ePM <sub>1</sub> 80%	900 m <sup>3</sup> /h
Nominal current*	2,6 A	
Nominal power consumption*	333 W	
Electrical connection with electric heating surface	3 x 400 V + N + PE / 50 Hz	
Duct connections	Ø315 mm	
Condensate drain, int. / ext.	5/8 mm	
Weight	210 kg	
Counterflow heat exchanger	2 x Aluminium	
Supply air filter	ePM <sub>10</sub> 75%, ePM <sub>1</sub> 55% or ePM <sub>1</sub> 80%	
Extract air filter	ePM <sub>10</sub> 75%	
Colour, panel	RAL 9010 (white)	
Recommended fuse	3x13 A	
Leakage current	≤ 7 mA	
Dimensions (WxHxD)	<b>H:</b> 1498 x 424 x 1384 mm	
	<b>S:</b> 1512 x 501 x 1385 mm	

\* At filter class, supply air/extract air: ePM<sub>10</sub> 75% / ePM<sub>10</sub> 75%

ELECTRIC HEATING SURFACE	
Heat output	2500 W
Thermal circuit breaker, aut. reset	75°C
Thermal circuit breaker, man. reset	120°C

WATER HEATING SURFACE*	
Max. operating temperature	90°C
Max. operating pressure	10 bar
Heat output	4099 W**
Connection dimension	1/2" (DN 15)
Materials pipes/fins	copper/aluminium
Open/close time, motor valve	60 s

\* Duct heating surface

\*\* Capacity at: supply/return temperature 60/40°C, water volume 180 l/h

STANDARD AND OPTIONS	DV 1000
Bypass	x
Electric heating surface/VPH	●
Water heating surface/VPH	●
CO <sub>2</sub> sensor (built-in)	●
Hygostat	●
Condensate pump	x
Cooling module	●
Motor driven exhaust air damper	●
Spring-return actuator on exhaust air damper	●
Motor driven supply air damper	●
Spring-return actuator on supply air damper	●
Counterflow heat exchanger (aluminium)	x
Energy meter	●

x : standard ● : option



# DV 1000

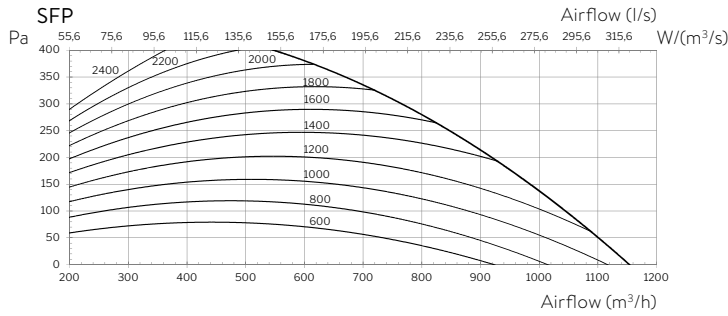

### Add extra pressure loss for ePM1, 55% Supply air filter.

$\Delta P = 0,0222 \cdot q_v$  [Pa]; ( $q_v$  = flow in  $m^3/h$ )  
 Pressure loss (p) incl. ePM1, 55% filter:  $p = p_s + \Delta p$  [Pa]

### Power consumption (P):

$P = SFP \cdot q_v / 3600$  [W];  
 (SFP from diagram and  $q_v$  = airflow in  $m^3/h$ )

### TEMPERATURE EFFICIENCY

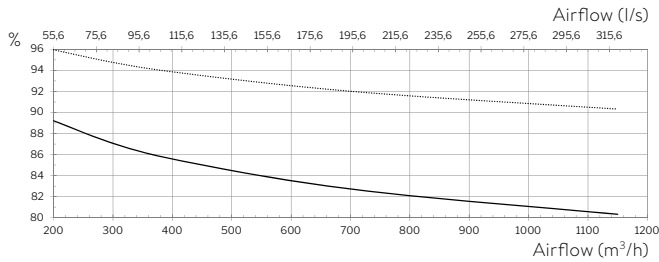

### 1: According to EN 308:1997 (without condensation)

Conditions: Indoor air: 25°C 28% RH  
 Outdoor air: 5°C

### 2: With condensation

Conditions: Indoor air: 25°C 55% RH  
 Outdoor air: -10°C

### SOUND POWER LEVEL $L_{WA}$ (A-weighted) cabinet acc. to EN ISO 3744

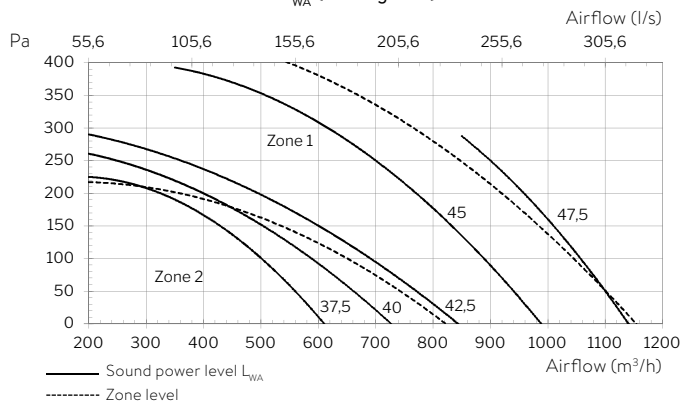

### SOUND POWER LEVEL - CABINET

HZ	ZONE 1 $K_W$	ZONE 2 $K_W$
63	13	13
125	8	11
250	6	6
500	-7	-9
1000	-12	-16
2000	-14	-16
4000	-20	-18
8000	-20	-17

$$L_W = L_{WA} + K_W$$

Sound power level  $L_{PA}$  must be calculated.

### SOUND POWER LEVEL $L_{WA}$ (A-weighted) pressure side acc. to EN ISO 5136

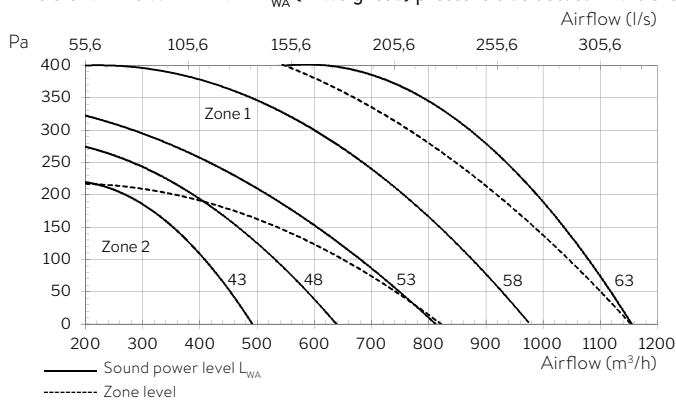

### SOUND POWER LEVEL - PRESSURE SIDE

HZ	ZONE 1 $K_W$	ZONE 2 $K_W$
63	-4	-5
125	-9	-4
250	-5	-7
500	-12	-13
1000	-15	-16
2000	-13	-15
4000	-20	-22
8000	-20	-29

$$L_W = L_{WA} + K_W$$

Sound power level  $L_{PA}$  must be calculated.

### SOUND POWER LEVEL $L_{WA}$ (A-weighted) suction side acc. to EN ISO 5136

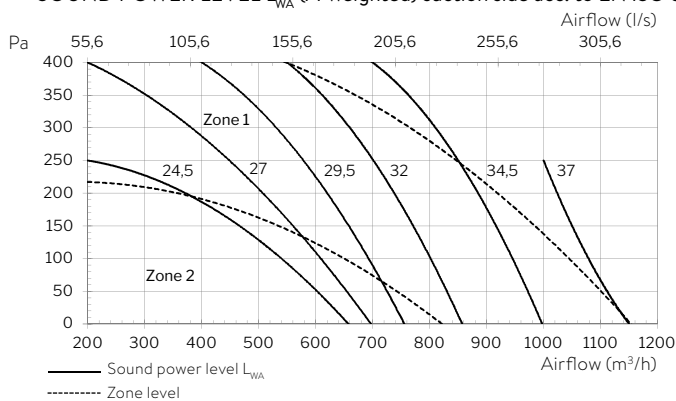

### SOUND POWER LEVEL - SUCTION SIDE

HZ	ZONE 1 $K_W$	ZONE 2 $K_W$
63	-2	-2
125	-9	-7
250	-8	-9
500	-18	-19
1000	-21	-22
2000	-25	-28
4000	-36	-38
8000	-42	-49

$$L_W = L_{WA} + K_W$$

Sound power level  $L_{PA}$  must be calculated.

# DV 1000

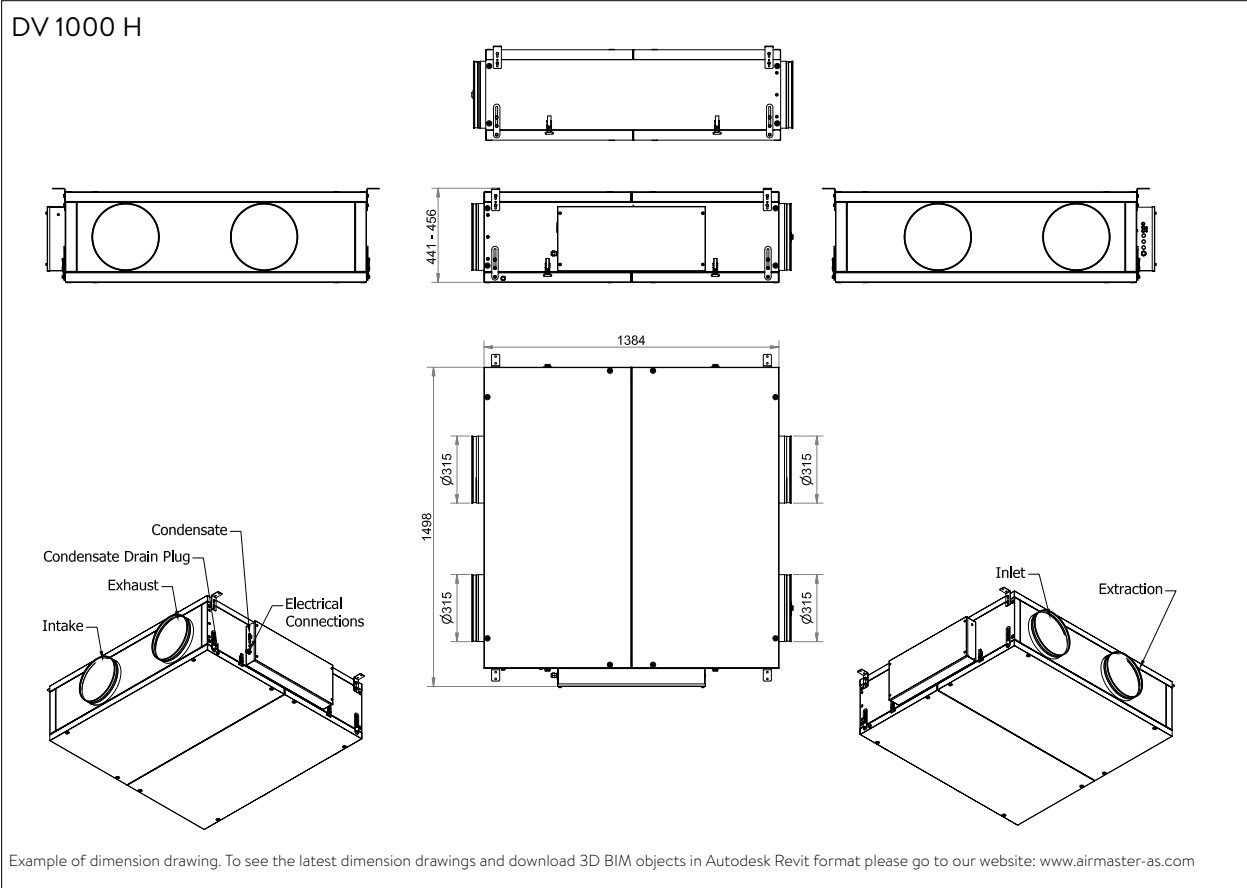

## SCHEMATIC SKETCH

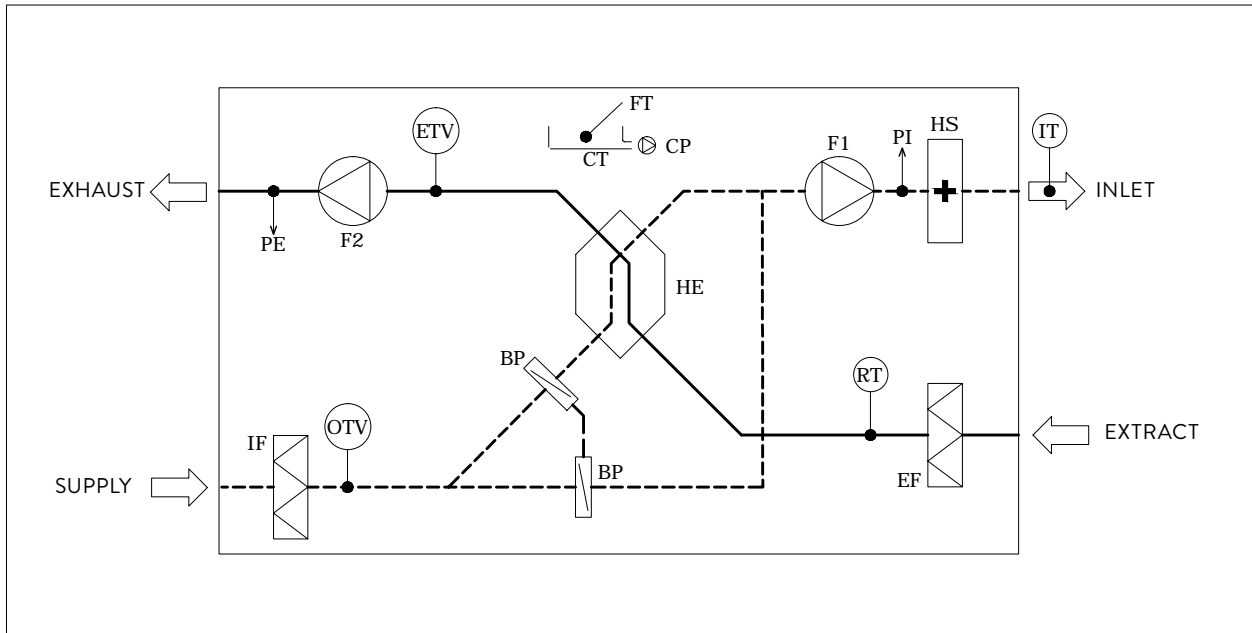

### NAME OF COMPONENT

BP	Bypass (motor driven)	FT	Float	IT	Inlet air temperature sensor
CP	Condensate tump	F1	Supply air fan	OTV	Outside temperature sensor
CT	Condensate tray	F2	Extract air fan	PE	Flow meter, extracted air
EF	Extract air filter	HE	Counterflow heat exchanger	PI	Flow meter, supply air
ETV	Exhaust temperature sensor	HS	Electric heating surface (option)	RT	Room temperature sensor
		IF	Supply air filter		

# CC 1000 COOLING MODULE

Read more about our inverter-controlled cooling modules on page 24.

## TECHNICAL DATA

Nominal cooling capacity*	6450 W
Min. cooling capacity*	1120 W
Nominal EER	4,45
Max. airflow	900 m <sup>3</sup> /h
Min. airflow**	360 m <sup>3</sup> /h
Electricity supply	1 x 230 V + N + PE / 50 Hz
Nominal electrical output	1449 W
Nominal current strength	8,9 A
Electrical output factor	0,71
Max. leakage current	2,0 mA
Coolant	R410a
Filling	770 g
Duct connection	Ø315 mm
Drain hose, internal/external diameter	Ø8/12 mm
Energy class	A+++
Weight	85 kg
Dimensions incl. unti (WxHxD)	1498 x 424 x 1898 mm

\* Measured according to EN 308 and EN 14825 at max. airflow with ePM<sub>10</sub> 75% filter.

\*\* Cooling module activation.

## SCHEMATIC SKETCH CC

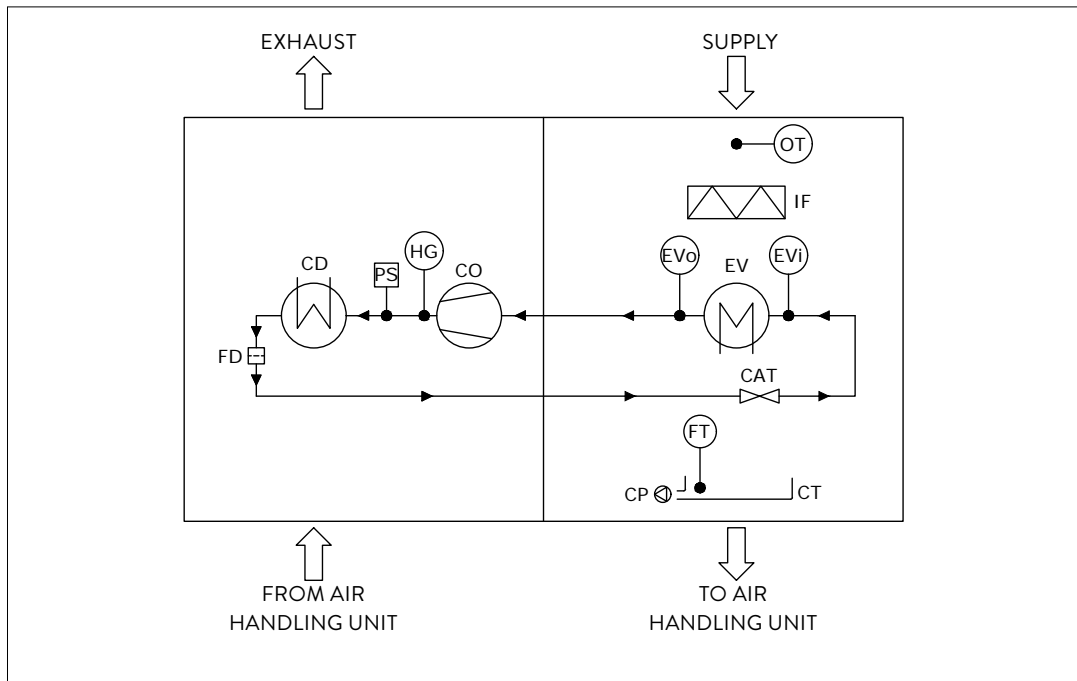

### NAME OF COMPONENT

CAT	Capillary Tube	EV	Evaporator	OT	Outside Temperature
CD	Condenser	EVi	Evaporator, temperature inlet	PS	Pressure Switch
CO	Compressor, inverter-controlled	EVo	Evaporator, temperature output		
CP	Condensate Pump	FD	Dry Filter		
CT	Condensate Tray	FT	Float		
		HG	Hot Gas Temperature		

# CC 1000 COOLING MODULE

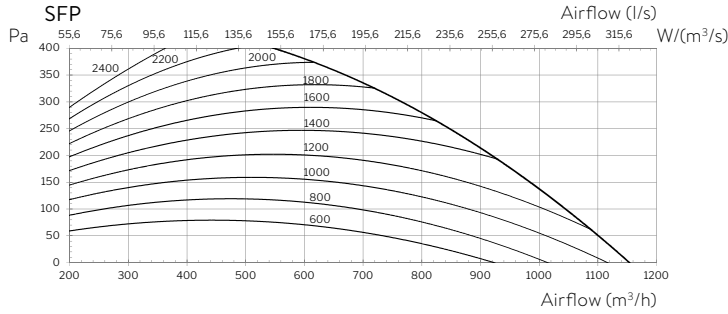

**Add extra pressure loss for ePM<sub>1</sub> 55% Supply air filter.**

$\Delta P = 0,0222 \cdot q_v$  [Pa]; ( $q_v$  = flow in m³/h)  
 Pressure loss (p) incl. ePM<sub>1</sub> 55% filter:  $p = p_s + \Delta p$  [Pa]

**Power consumption (P):**

$P = SFP \cdot q_v / 3600$  [W];  
 (SFP from diagram and  $q_v$  = airflow in (m³/h))

## TEMPERATURE EFFICIENCY

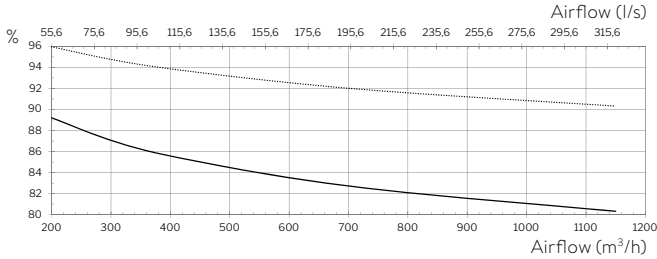

## SOUND POWER LEVEL $L_{WA}$ (A-weighted) cabinet acc. to EN ISO 3744

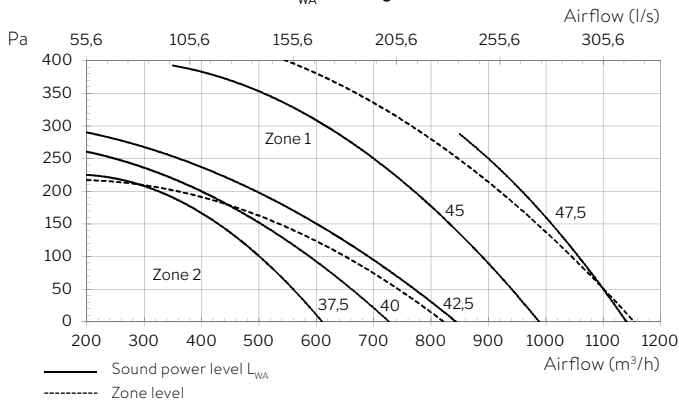

## SOUND POWER LEVEL - CABINET

HZ	ZONE 1 $K_W$	ZONE 2 $K_W$
63	13	13
125	8	11
250	6	6
500	-7	-9
1000	-12	-16
4000	-20	-18
8000	-20	-17

$L_W = L_{WA} + K_W$

Sound power level  $L_{PA}$  must be calculated.

## SOUND POWER LEVEL $L_{WA}$ (A-weighted) pressure side acc. to EN ISO 5136

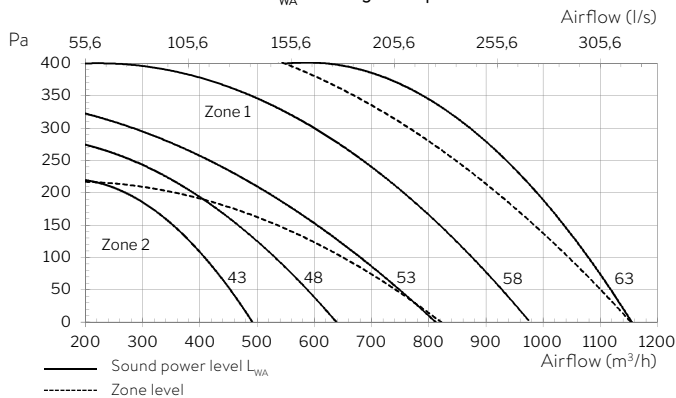

## SOUND POWER LEVEL - PRESSURE SIDE

HZ	ZONE 1 $K_W$	ZONE 2 $K_W$
63	-4	-5
125	-9	-4
250	-5	-7
500	-12	-13
1000	-15	-16
2000	-13	-15
4000	-20	-22
8000	-20	-29

$L_W = L_{WA} + K_W$

Sound power level  $L_{PA}$  must be calculated.

## SOUND POWER LEVEL $L_{WA}$ (A-weighted) suction side acc. to EN ISO 5136

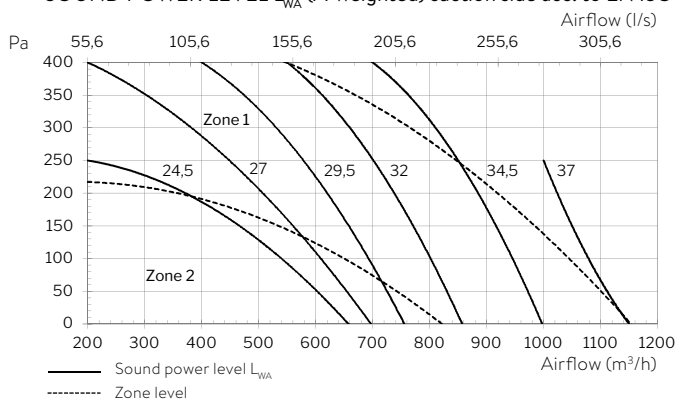

## SOUND POWER LEVEL - SUCTION SIDE

HZ	ZONE 1 $K_W$	ZONE 2 $K_W$
63	-2	-2
125	-9	-7
250	-8	-9
500	-18	-19
1000	-21	-22
2000	-25	-28
4000	-36	-38
8000	-42	-49

$L_W = L_{WA} + K_W$

Sound power level  $L_{PA}$  must be calculated.

# INTELLIGENT CONTROL WITH AIRLINQ®

Airmaster focuses not only on the air handling unit, but also on the control system and operation.

All Airmaster decentralised air handling units are controlled by our intelligent, fully automatic control system - Airlinq.

Airlinq makes it possible to use units immediately after installation, as all basic functions are preprogrammed at the factory.

The Airlinq control system is able to automatically counter high and low inlet temperatures, to ensure the room temperature set is maintained. Effective protection functions prevent the heat exchanger from icing up, drain off condensation and automatically stop the unit if necessary. Unnecessary damage to the unit is therefore prevented.

The system is easy to set and program to individual requirements from customers or for local conditions. The software controls the options installed automatically, such as bypass, heating surfaces, cooling module and sensors (CO<sub>2</sub>, humidity, motion etc.) whenever required.

# CONTROL FUNCTIONS WITH AIRLINQ®:



## DATA LOG

Unique log function for all key operating and room data such as:

- Inlet temperature
- Room temperature
- Outside temperature
- CO<sub>2</sub> level
- Air humidity
- Airflow
- Damper position



## AIRLINQ PC TOOLS

User-friendly monitoring and setting of air handling units via PC with Airlinq User Tool.

Service engineers can use the more advanced Airlinq Service Tool.



## DOWNLOAD TO PC

The unit's operating data can be downloaded to a PC to provide rapid overview of operation, and to generate operating documentation. This allows full optimisation of the unit.



## ALL-IN-ONE

All intelligence is concentrated in the unit, which means that it can run fully automatically without having to be connected to a control panel.



## MONITORING, WARNING AND ALARM SYSTEM

The advanced warning and alarm system helps minimise operating and service costs. Errors are quickly detected, making the unit more reliable.



## FLEXIBILITY WITH DIGITAL BMS

Airlinq can be fitted with a network module (optional PCB) to provide flexible connection to one of the following network systems:

- KNX®
- BACnet™/IP
- BACnet™ MS/TP
- LON®
- MODBUS® RTU RS485
- Airlinq® Online



## AIRLINQ BMS

Up to 20 different and individually equipped air handling units can be controlled using a single control panel in an Airlinq BMS.



## AIRMASTER SENSORER FOR BMS

Airmaster's motion sensor (PIR) and CO<sub>2</sub> sensors can be used on network systems. The result is very simple and inexpensive connection to a BMS system.

# AIRLINQ® ORBIT CONTROL PANEL

Operation using Airlinq Orbit is perfect when more comprehensive and easier access is required to control normal ventilation operation.

## WIDE RANGE OF OPTIONS

Operating functions provide a wide range of options for controlling ventilation. The Airlinq Orbit control panel with touch function is user-friendly for navigation and setting operating parameters. The menu layout makes operation easy and simple, and reduces the risk of error.



Data cable

## OPERATION

Settings can be made directly on the control panel touch screen.



USB cable



## AIRLINQ SERVICE TOOL

The control panel can be easily connected to a PC, providing access to operating data using the Airlinq User Tool.

- Setting and programming control system
- Download a data log and graphic record of operation
- Download or upload a control system setup
- Monitor energy consumption using a built-in energy meter
- Update control system software
- Automatic synchronisation of the built-in timer via PC date and time



## OPERATION VIA PC

A PC can be connected via the USB port on the control panel, and Airlinq Service Tool used to set all operating parameters. (Airlinq Service Tool is for the use of service engineers).

Airlinq User Tool and Airlinq Service Tool can be downloaded from [www.airlinq.eu](http://www.airlinq.eu)

# CONTROL FUNCTIONS WITH AIRLINQ® ORBIT



Manual start, stop and standby. Manual start and stop of an individual group or entire system for Airlinq BMS.



Setting of all major operating parameters using an automatic startup guide. The start-up guide can be restarted at any time.



Display and setting air flow via touch function on the front.



Displays warnings and alarms with text description (for all Airlinq BMS units).



Holiday mode - a function to ensure basic ventilation with reduced airflow.



Displays CO<sub>2</sub> level when a CO<sub>2</sub> sensor is connected (for all CO<sub>2</sub> sensors on Airlinq BMS).



Easy, simple control of Airlinq BMS.



Automatic operating lock.



Screen lock with security code.



## SET OPERATING PARAMETERS:

- Display operating status for up to 40 operating parameters (for all units with Airlinq BMS)
- Overview and settings for all timed programs, including night time cooling
- Inlet temperature and standard airflow
- Set date and time
- Cancel service
- Modify data log





# AIRLINQ® VIVA CONTROL PANEL

The Airlinq Viva is designed to be perfect for any requirement for optimal ventilation with minimal manual control.

## THE EASIEST CONTROL INTERFACE ON THE MARKET

Control functions are simple and user-friendly. Operation is automatic to minimise the risk of incorrect use.

## OPERATION VIA PC

The control panel can be connected to a PC via a USB port to set other operating parameters. Airlinq User Tool and Airlinq Service Tool (programs used by service engineers) provide complete details of the unit's performance. See the following description of options for the two programs.



### AIRLINQ USER TOOL

The control panel can be easily connected to a PC, providing access to operating data using the Airlinq User Tool.

- Options include setting airflow, inlet-temperature and maximum room temperature
- Filter status display
- Setting CO<sub>2</sub> range
- Setting, activating and deactivating timer programs



### AIRLINQ SERVICE TOOL

The control panel can be easily connected to a PC, providing access to operating data using the Airlinq Service Tool.

- Setting and programming the control program can be performed
- Downloadable data log and graphic display
- Downloadable and uploadable control system setup
- Updating control system software
- Automatic synchronisation of the built-in timer via PC date and time

Airlinq User Tool and Airlinq Service Tool can be downloaded from [www.airlinq.eu](http://www.airlinq.eu)

# CONTROL FUNCTIONS WITH AIRLINQ® VIVA

Manual start, stop and standby.

Setting airflow via touch function on the front.

Display of warnings and alarms by red or yellow symbols.

Holiday mode - a function to ensure basic ventilation with reduced airflow.

Automatic operation lock.

Child lock.



The control panel allows the user to adjust airflow easily.

# NETWORK WITH AIRMASTER

Network control can be performed using Airlinq BMS, with which up to 20 units can be controlled from a single Airlinq Orbit control panel.

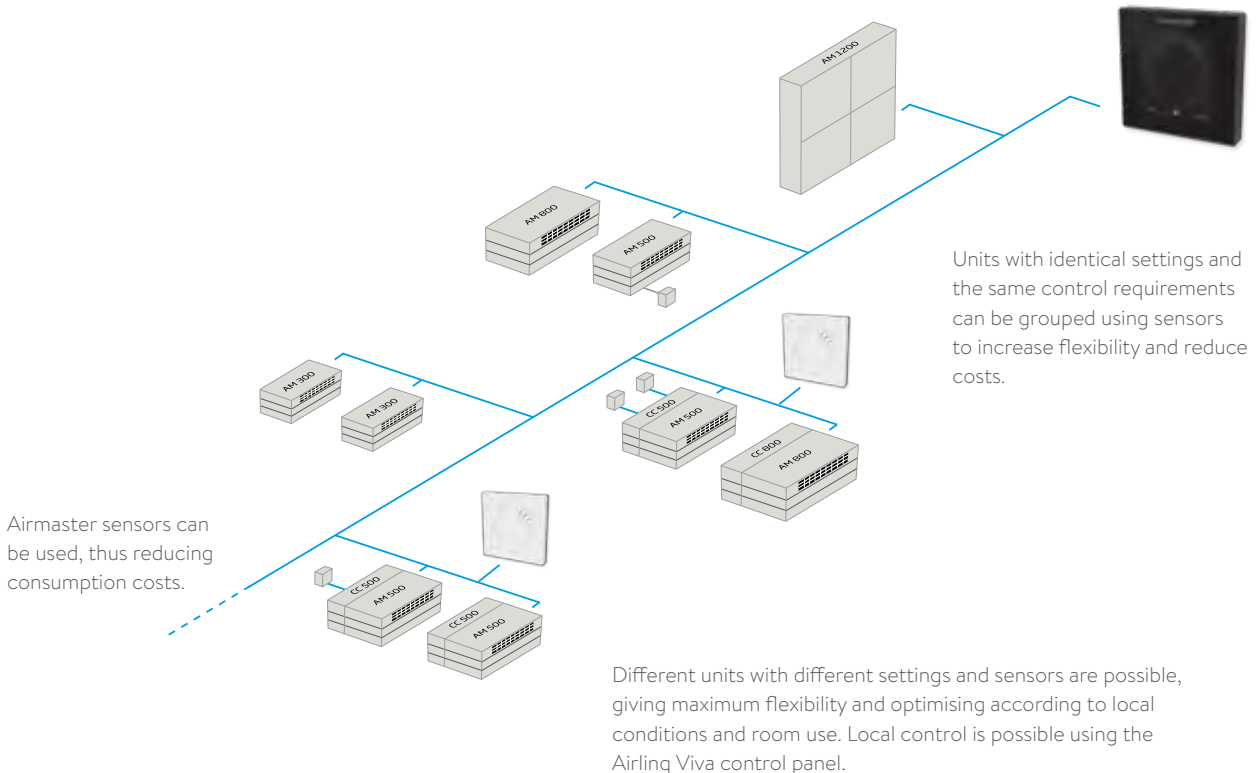

## AIRLINQ BMS

Flexibility is the order of the day for the Airlinq BMS system. BMS stands for "Building Management System".

Up to 20 different air handling units can be controlled by the system from a single control panel. The units can be different types and fitted with different options.

Cooling modules can also be attached to individual units as and when required. Such a degree of flexibility means that units with different levels of performance and options can be connected to a single system, whilst meeting the requirements of any individual room.

Dividing the system into groups of one or more units with a common control system optimises use of their size and sensors.

Control using a single sensor (e.g. CO<sub>2</sub> sensor) or a combination (e.g. a motion sensor and a CO<sub>2</sub> sensor) is also possible. Using sensors overrides the basic operating parameters for individual units, whole groups or all units.

Individual operation, monitoring and programming - plus programming of common parameters - are performed from a single control panel. Connection to an analogue building network (BMS system) is of course also possible.

## DIGITAL BMS

A BMS (Building Management System) network makes it possible to keep all the benefits of decentralised ventilation, whilst utilising the administrative benefits of central control.

Airmaster air handling units are easy integrate with other building automation.

Creating a full overview of operations and programmable air handling units in relation to local use is easy with a Building Management System (BMS).

The units can also run fully automatically, but can be monitored using a BMS network. Airmaster motion sensor and CO<sub>2</sub> sensors can be connected, for data from the units and sensors can be transferred to the BMS network. This reduces installation, operation and maintenance costs.

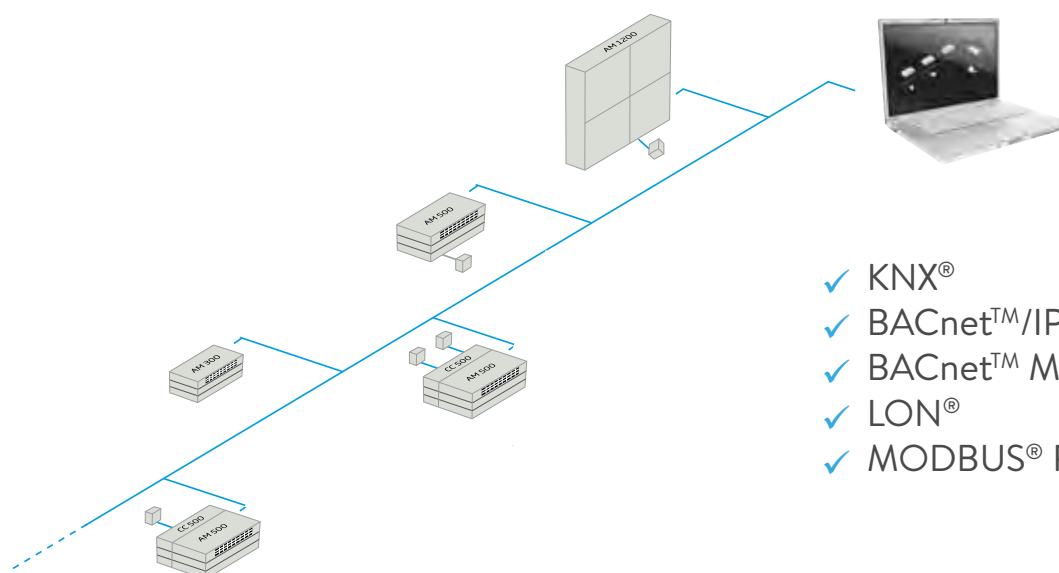

- ✓ KNX®
- ✓ BACnet™/IP
- ✓ BACnet™ MS/TP
- ✓ LON®
- ✓ MODBUS® RTU RS485

When the control system is connected to BMS, all individual air handling units can be controlled and/or monitored by BMS.

# AIRMASTER AIRLINQ<sup>®</sup> ONLINE

Airmaster Airlinq<sup>®</sup> Online is a cloud based WEB portal, where the user is able to control, monitor, and manage all of the installed Airmaster air handling units (AHU) of a project. The WEB portal is accesable from both PC, smarthphone and tablet.



The Airlinq Online WEB portal gives the user an overview and access to operation and monitoring of installed Airmaster AHU of a project.

Airmaster Airlinq Online is much more than just a web service. It is a total package, which includes that Airmaster in cooperation with the customer makes the setup of the project and ensures correct connection and setup for each AHU on the WEB portal. Furthermore, Airmaster provides fundamental instructions and training in using the system. Hereby ensuring maximum user satisfaction. Airmaster Airlinq Online includes 3 years, free of charge, software update of the firmware for the air handling unit.

The setup of each AHU includes, besides setup of operating parameters, also the fundamental setup of user groups and registration of authorised users with associated permissions and rights.

The setup of each AHU ensures that the customer gets the overview and availability of the project customized to his needs. Furthermore, the operation of each AHU is individually adjusted to the project.

This way the energy consumption can be kept at a minimum by ensuring an efficient operation setup.

# OVERVIEW & PEACE OF MIND AS A MATTER OF COURSE

Airmaster Airlinq® Online meets your needs for centralised administration while retaining the benefits of decentralised ventilation. As a municipality, housing association, property manager, caretaker and end user, you gain a quick and easy overview of all your ventilation units.

- Online control
- Online operation
- Online operational monitoring

## Security

As much as we favour openness, security is also paramount at Airmaster. All communication is therefore securely encrypted, whether between user and server or between ventilation unit and server.

## Connection to Airmaster Airlinq® Online

Airmaster ventilation units can be connected to Airmaster Airlinq® Online in two ways: Connection to Airmaster Airlinq® Online is possible using a standard Ethernet cable (min. Cat 5e) for each individual Airmaster ventilation unit. Requires a network socket for all ventilation units or alternatively a switch.

Connection to Airmaster Airlinq® Online is also possible using a standard Ethernet cable (min. Cat 5e) for one Airmaster ventilation unit which is part of an Airlinq BMS system.

The units can communicate with Airmaster Airlinq® Online via the RS-485 bus connection established to the Airlinq BMS system. This solution requires a single network socket for one of the ventilation units in an Airlinq BMS system. One Airlinq BMS system can handle up to 20 ventilation units.

## Connection to BMS systems

If you wish to integrate the control and operation of Airmaster ventilation units with other building automation, this is also a possibility. On page 89, we have described Networks with Airmaster using BACnet™ and MODBUS®, for example, but there is another option. If you have Airmaster Airlinq® Online, you can connect to BMS systems from here using the Airlinq® Online API. Whether you want the entire control unit to be integrated or just certain sub-functions such as operational monitoring, the API can facilitate integration.

For further information regarding Airlinq® Online and Airlinq Online API, please visit:  
[www.airmaster-as.com/en/products/control-and-operation/airlinq-online](http://www.airmaster-as.com/en/products/control-and-operation/airlinq-online)

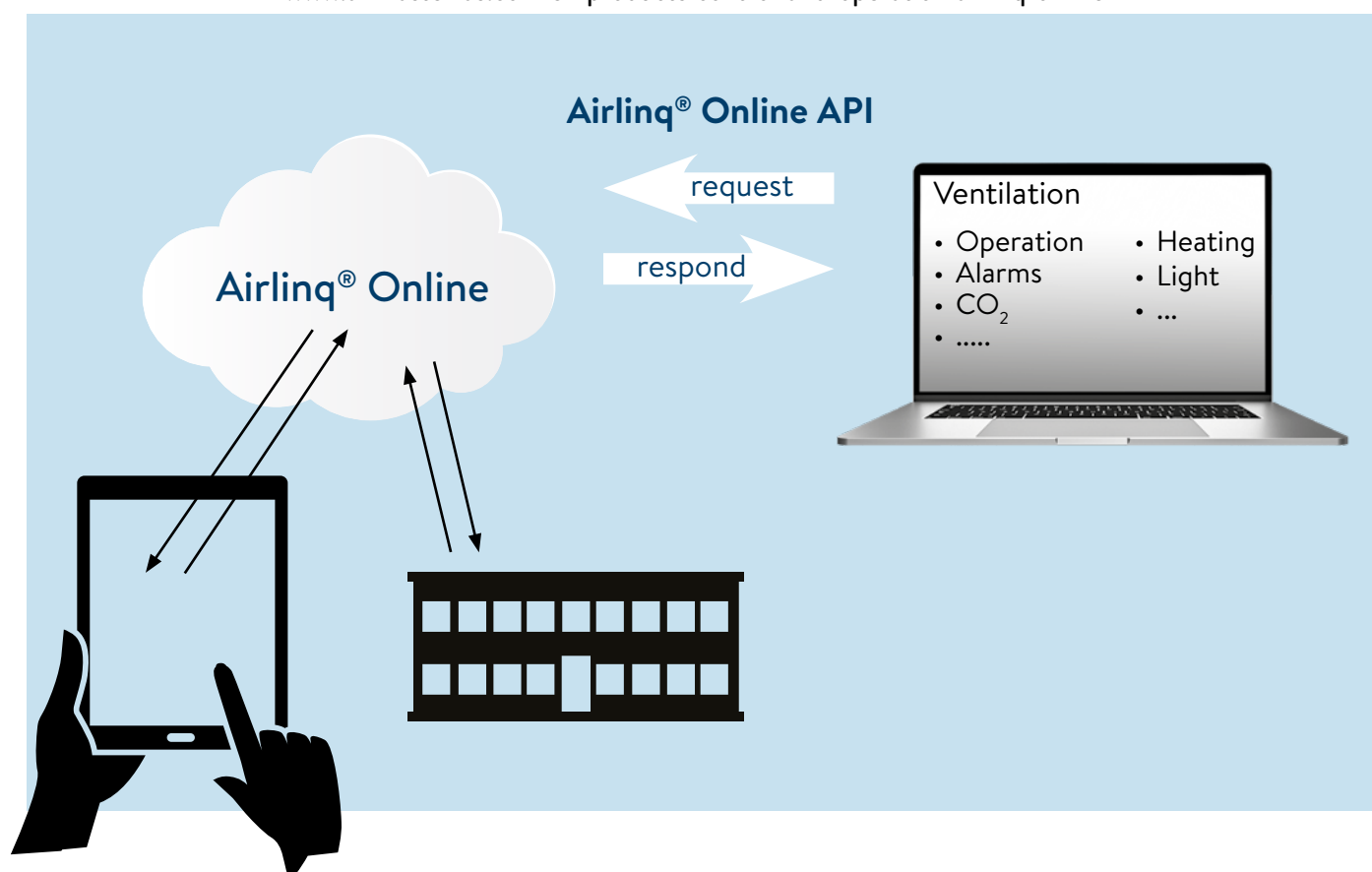

# VENTILATION GRILL



## Airmaster Boomerain® Ø160 mm, Ø250 mm and Ø315 mm

Façade ventilation grill in a new, aerodynamic design, developed for Airmaster ventilation units. The shape of the slats has been designed in such a way that only very limited turbulence occurs on the reverse of the façade ventilation grill. Pressure loss is thus reduced, and energy consumption is reduced considerably. The unique geometry is furthermore designed to capture water droplets and channel them away, preventing penetration into the duct.

Airmaster Boomerain® is made of salt waterresistant aluminium, and can, as an option, be supplied powder coated in all RAL colours.

There are three variants in each size:



### Airmaster Boomerain® 1

is a façade ventilation grill with a single layer of slats, which is ideal for an ordinary inland climate under protective conditions in a relatively passive environment.



### Airmaster Boomerain® 2

is a façade ventilation grill with a double layer of slats, providing greater protection from rainwater. We recommend it in more exposed places, which are occasionally lashed by westerly winds, for example.



### Airmaster Boomerain® 3

is a façade ventilation grill with three layers of slats, which are extra effective at keeping the rain out. It is designed for harsh weather conditions, such as in coastal areas where extra protection may be needed.

	Ø160-1	Ø160-2	Ø160-3	Ø250-1	Ø250-2	Ø250-3	Ø315-1	Ø315-2	Ø315-3
Ød	157 mm	157 mm	157 mm	250 mm	250 mm	250 mm	312 mm	312 mm	312 mm
ØD	215 mm	215 mm	215 mm	305 mm	305 mm	305 mm	370 mm	370 mm	370 mm
h	53 mm	104 mm	155 mm	53 mm	126 mm	177 mm	53 mm	104 mm	155 mm
H	72 mm	118 mm	174 mm	72 mm	140 mm	196 mm	72 mm	118 mm	174 mm
Free area	0,015 m <sup>2</sup>	0,015 m <sup>2</sup>	0,015 m <sup>2</sup>	0,038 m <sup>2</sup>	0,038 m <sup>2</sup>	0,038 m <sup>2</sup>	0,0624 m <sup>2</sup>	0,0624 m <sup>2</sup>	0,0624 m <sup>2</sup>
Weight	≈ 1 kg	≈ 1,5 kg	≈ 2 kg	1,72 kg	2,66 kg	3,62 kg	2,12 kg	3,64 kg	5 kg

Boomerain® 1

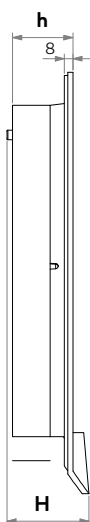

Boomerain® 2

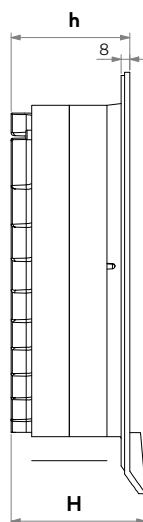

Boomerain® 3

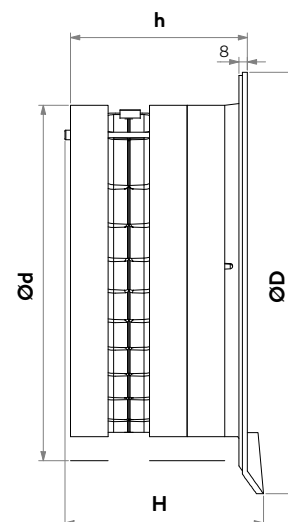

# INSTALLATION AND FITTINGS



## **FACADE GRILLE**

supplied with built-in bird net, and protects against driving rain.



## **WALL COVER**

for the AM 900 - used when supply and exhaust have to be close together and prevents external short circuit.



## **STORM CAP**

can be used when the supply and exhaust are particularly exposed to wind.



## **WALL FRAME**

for AM 150, AMC 150, AM 300, AM 500, AM 800, AM 1000 and is also used for all cooling modules.

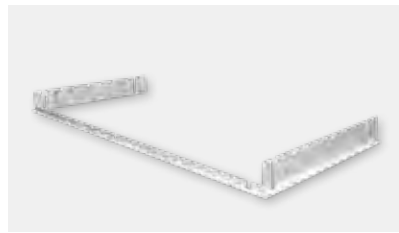

## **CEILING FRAME**

for AM 150, AMC 150, AM 300, AM 500 and AM 800.



## **CEILING BRACKET**

for DV 1000.



## **CEILING BRACKETS**

for mounting direct on ceiling as support if a wall provides an unsatisfactory mounting point.



## **ADJUSTABLE CEILING BRACKETS**

height adjustable.



## **VAPOUR BARRIER MEMBRANE**

used around pipes penetrating walls or roofs. Ensures tight vapour membrane after ducting.



# ROOF PENETRATION SET



A complete roof penetration set consists of  
 2 insulated penetration ductings,  
 2 roof covers,  
 1 exhaust cap,  
 1 louvred cap,  
 2 bushings and  
 3 metres spiral pipe.

## ROOF CAP MODULE

AM 900 / AM 1200	Ød	ØD	H	H x B x D
Exhaust cap	315	450	540	-
Louvred cap	315	450	540	-
Box housing AM 900	-	-	-	1000 x 950 x 500
Box housing AM 1200	-	-	-	1004 x 884 x 434

Int. dia. = internal diameter · Ext. dia. = external diameter · H = height

A roof cap module is used on roofing felt roofs with a pitch of 0-30° for AM 900 V and AM 1200 V. Exhaust and louvred caps are integrated into a box housing.

Please remember to state roof pitch when ordering.



# EXHAUST CAP

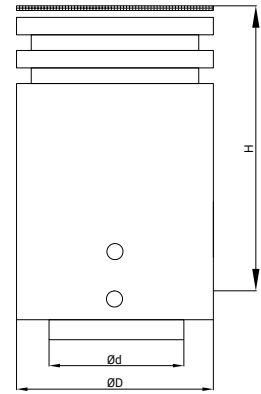

	Ød	ØD	H
AM 150 / AMC 150	125	250	230
AM 300	160	280	310
AM 500	250	355	437
AM 800			
AM 900			
DV 1000	315	450	540
AM 1000			
AM 1200	400	500	700

Int. dia. = internal diameter · Ext. dia. = external diameter · H = height  
 NB: the height measurements stated are to the upper edge of the lowest hole.  
 The exhaust cap has the same external dimensions as Airmaster's insulated pipes to ensure a good fit.  
 Also available in black at extra charge.



# LOUVRED CAP

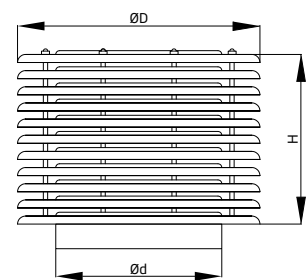

	Ød	ØD	H
AM 150 / AMC 150	125	250	130
AM 300	160	280	180
AM 500	250	355	191
AM 800			
AM 900			
DV 1000	315	450	222
AM 1000			
AM 1200	400	500	284

Int. dia. = internal diameter · Ext. dia. = external diameter · H = height  
 The louvred cap has the same external dimensions as Airmaster's insulated pipes to ensure a good fit.  
 Also available in black at extra charge.



# ROOF COVERS

	Ød
AM 150 / AMC 150	250
AM 300	280
AM 500	400
AM 800	
AM 900 / AM 1200	450
DV 1000	
AM 1000	
AM 1200	500

Int. dia. = internal diameter.

Roof covers are available in galvanised or grey preformed sheet metal, both with a galvanised sheet metal pipe collar.

Also available in black at extra charge.

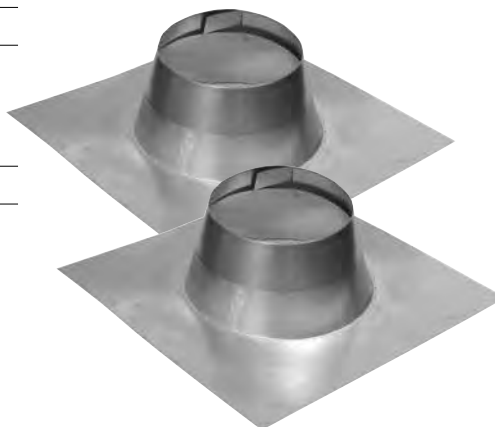
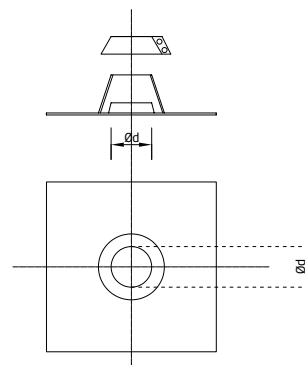

# INSULATED PENETRATION DUCTING

	Ød	ØD
AM 150 / AMC 150	125	250
AM 300	200	280
AM 500	250	400
AM 800		
AM 900		
DV 1000	315	450
AM 1000		
AM 1200	400	500

Int. dia. = internal diameter · Ext. dia. = external diameter.

Insulated penetration ducting with minimum 50 mm insulation.

Length depends on roof pitch:

Pitch 0° - 30° = length 900 mm · Pitch 31° - 45° = length 1200 mm

Also available in black at extra charge.

L = AM 900 / AM 1200 afhængig af taghældningen.

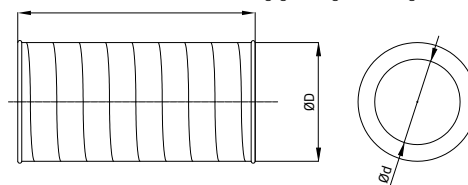



# TECHNICAL DATA

FILTERCLASS			AM 150	AM 300	AM 500	AM 800
Maximum capacity at 30 dB(A)	ePM <sub>10</sub> 75%	m <sup>3</sup> /h	115	210 <sup>1</sup>	430	650
	ePM <sub>1</sub> 55%		90	205 <sup>1</sup>	387	585
	ePM <sub>1</sub> 80%		85	180 <sup>1</sup>	344	520
Maximum capacity at 35 dB(A)	ePM <sub>10</sub> 75%	m <sup>3</sup> /h	147	275	550	725
	ePM <sub>1</sub> 55%		126	270	495	653
	ePM <sub>1</sub> 80%		115	240	440	580
Throw length (0.2 m/s) at 30 dB(A)	ePM <sub>10</sub> 75%	m	2,6 m at 115	4,25 m at 210	5,9 m at 430	7,7 m at 650
	ePM <sub>1</sub> 55%		2,1 m at 90	4,25 m at 205	5,4 m at 387	7,2 m at 585
	ePM <sub>1</sub> 80%		1,9 m at 85	3,5 m at 180	4,8 m at 344	6,7 m at 520
Throw length (0.2 m/s) at 35 dB(A)	ePM <sub>10</sub> 75%	m	3,4 m at 147	6 m at 275	7,5 m at 550	8,3 m at 725
	ePM <sub>1</sub> 55%		2,8 m at 126	6 m at 270	6,7 m at 495	7,7 m at 653
	ePM <sub>1</sub> 80%		2,6 m at 115	5 m at 240	6,0 m at 440	7,2 m at 580
Nominal current*		A	0,3	1,45**	1,1	1,1
Nominal power consumption*		W	38	175 ***	132	156
Electrical connection		V/Hz	1 x 230 V + N + PE / 50 Hz	1 x 230 V + N + PE / 50 Hz	1 x 230 V + N + PE / 50 Hz	1 x 230 V + N + PE / 50 Hz
Duct connections		mm	Ø125	Ø160	Ø250	Ø315
Condensate drain		mm		Ø4/6	Ø16	Ø16
Weight, air handling unit (excl. options)		kg	47	85	108	157
Counterflow heat exchanger			PET	Aluminium	Aluminium	2 x Aluminium
Supply air filter			ePM <sub>10</sub> 75%, ePM <sub>1</sub> 55% or ePM <sub>1</sub> 80%	ePM <sub>10</sub> 75%, ePM <sub>1</sub> 55% or ePM <sub>1</sub> 80%	ePM <sub>10</sub> 75%, ePM <sub>1</sub> 55% or ePM <sub>1</sub> 80%	ePM <sub>10</sub> 75%, ePM <sub>1</sub> 55% or ePM <sub>1</sub> 80%
Extract air filter			ePM <sub>10</sub> 75%	ePM <sub>10</sub> 75%	ePM <sub>10</sub> 75%	ePM <sub>10</sub> 75%
Colour, panel		RAL		9010	9010	9010
Colour, casing		RAL	9010		7024	7024
Electrical output factor			0,55	0,53	0,58	0,56
Power cable		mm <sup>2</sup>	3 x 0,75	3 x 1,5	3 x 1,5	3 x 1,5
Recommended fuse		A	10	10	10	13
Fuse (max.)		A	13	16	16	16
Leakage current (max.)		mA	≤0,5	≤ 0,7 mA / ≤ 0,005 mA	≤6	≤6
Energy class (SEC class)			A	A		
Air leakage classification			Class L1 cf. EN 1886 Class A1 cf. EN 13141-7	Class L2 cf. EN 1886 Class A1 cf. EN 13141-7	Class L2 cf. EN 1886 Class A2 cf. EN 13141-7	Class L2 cf. EN 1886 Class A1 cf. EN 13141-7
Dimensions (WxHxD)		mm	1170 x 261 x 572	1180 x 344 x 705	1600 x 439 x 779	1910 x 474 x 916
<b>ELECTRIC HEATING SURFACE</b>						
Thermal circuit breaker, aut. reset		°C	75		75	75
Thermal circuit breaker, man. reset		°C	90	120	120	120
Electric comfort heater output		W		1000	630	1000
Current		A		4,35	2,6	4,4
Electric preheater output		W		2500	1000	1500
Current		A		10,87	4,4	6,5
Heating surface (VPH)*		W	600			
Nominal current		A	2,6			
<b>WATER HEATING SURFACE</b>						
Output at 60/40°C supply/return		W		1973	858	1379
Max. operating temperature		°C		90	90	90
Max. operating pressure		bar		10	10	10
Connection dimension				1/2" (DN15)	3/8" (DN10)	1/2" (DN 15)
Materials				copper /aluminium	copper/aluminium	copper/aluminium
Open/close time, motor valve		s		60	60	60
<b>CONDENSATE PUMP</b>						
Maximum capacity		l/h	10	10	10	10
Maximum lift height		m	6	6	6	6

\* VPH: Virtual Preheat

\*\* Maximum / nominal current at 30dB(A) / 35 dB(A) / BOOST<sup>1</sup> - 175 W / 55 W / 102 W / 123 W

\*\*\* Maximum / nominal power consumption at 30dB(A) / 35 dB(A) / BOOST<sup>1</sup> - 1,45 A / 0,45 A / 0,88 A / 1,01 A

<sup>1</sup>All measurements were performed in normal operating mode in a standard installation for the filter class, supply/extract air: ePM10 75% / ePM10 75%, using the facade grills recommended by Airmaster: Airmaster Boomerain® Ø160, in a test room dimensioned 8.0 m x 10.0 m x 2.5 m with room attenuation of 7.5 dB

# TECHNICAL DATA

FILTERCLASS			AM 900 (mixed)	AM 900 (displacement)	AM 1000	AM 1200
Maximum capacity at 30 dB(A)	ePM <sub>10</sub> 75% ePM <sub>1</sub> 55% ePM <sub>1</sub> 80%	m <sup>3</sup> /h	690 669 649	650 631 611	950 926 903	820-1050 738-945 656-840
Maximum capacity at 35 dB(A)	ePM <sub>10</sub> 75% ePM <sub>1</sub> 55% ePM <sub>1</sub> 80%	m <sup>3</sup> /h	830 805 780	800 776 752	1050 1024 998	1060-1310 954-1179 848-1049
Throw length (0.2 m/s) at 30 dB(A)	ePM <sub>10</sub> 75% ePM <sub>1</sub> 55% ePM <sub>1</sub> 80%	m	6 m at 690 m <sup>3</sup> /h	Adjacent zone to outlet, approx. 1,2 m at 650 m <sup>3</sup> /h	10,5 m	min. 3 m at 1000 <sup>1</sup> max. 6,5 m at 1000 <sup>1</sup> min. 4 m at 1300 <sup>1</sup> max. 8 m at 1300 <sup>1</sup>
Throw length (0.2 m/s) at 35 dB(A)	ePM <sub>10</sub> 75% ePM <sub>1</sub> 55% ePM <sub>1</sub> 80%	m	7,2 m at 830 m <sup>3</sup> /h	Adjacent zone to outlet, approx. 1,5 m at 800 m <sup>3</sup> /h	10,5 m	min. 4 m at 1000 <sup>2</sup> max. 9 m at 1000 <sup>2</sup> min. 5,5 m at 1300 <sup>2</sup> max. 11 m at 1300 <sup>2</sup>
Nominal current*		A	1,8	1,8	2,2	1,4
Nominal power consumption*		W	240	240	305	254
Electrical connection		V/Hz	1 x 230 V + N + PE / 50 Hz	1 x 230 V + N + PE / 50 Hz	3 x 400 V + N + PE / 50 Hz	3 x 400 V + N + PE / 50 Hz
Duct connections		mm	Ø315	Ø315	Ø315	Ø315/Ø400
Condensate drain		mm	Ø4/6	Ø4/6	Ø4/6	Ø16
Weight, air handling unit (excl. options)		kg	180	180	301,5	545/630
Counterflow heat exchanger			3 x PET	3 x PET	2 x Aluminium	4 x Aluminium
Supply air filter			ePM <sub>10</sub> 75%, ePM <sub>1</sub> 55% or ePM <sub>1</sub> 80%	ePM <sub>10</sub> 75%, ePM <sub>1</sub> 55% or ePM <sub>1</sub> 80%	ePM <sub>10</sub> 75%, ePM <sub>1</sub> 55% or ePM <sub>1</sub> 80%	ePM <sub>10</sub> 75%, ePM <sub>1</sub> 55% or ePM <sub>1</sub> 80%
Extract air filter			ePM <sub>10</sub> 75%	ePM <sub>10</sub> 75%	ePM <sub>10</sub> 75%	ePM <sub>10</sub> 75%
Design panel dimensions		mm				1200 x 1000
Colour, panel		RAL	9010	9010	9010	9010
Colour, casing		RAL	7024	7024	7024	7024
Min. ceiling height for horizontal supply/exhaust		mm	2490	2490		2400
Min. ceiling height for vertical supply/exhaust		mm	2490	2490		2500
Electrical output factor			0,60	0,60	0,60	0,60
Power cable		mm <sup>2</sup>	3 x 1,5	3 x 1,5	5 x 2,5	3 x 1,5
Recommended fuse		A	13	13	3x13	3x13
Fuse (max.)		A	16	16	3x16	3x16
Leakage current (max.)		mA	≤6	≤6	≤4	≤9
Air leakage classification					Class L2 cf. EN 1886 Class A1 cf. EN 13141-7	
Dimensions (WxHxD)		mm	800 x 2323 x 602	800 x 2323 x 687	2325 x 561 x 1283	496 x 2098 x 2427
<b>ELECTRIC HEATING SURFACE</b>						
Thermal circuit breaker, aut. reset		°C	75	75	75	75
Thermal circuit breaker, man. reset		°C	120	120	120	120
Electric comfort heater output		W	1050	1050	1500	1670
Current		A	4,4	4,4	6,5	7,3
Electric preheater output		W	1500	1500	2300	2500
Current		A	6,5	6,5	10	10,9
<b>WATER HEATING SURFACE</b>						
Output at 60/40°C supply/return		W	2345	2345	2540	2454
Max. operating temperature		°C	90	90	90	90
Max. operating pressure		bar	10	10	10	10
Connection dimension			1/2" (DN 15)	1/2" (DN 15)	1/2" (DN 15)	1/2" (DN 15)
Materials			copper/aluminium	copper/aluminium	copper/aluminium	copper/aluminium
Open/close time, motor valve		s	60	60	60	60
<b>CONDENSATE PUMP</b>						
Capacity		l/h	10	10	10	10
Lift height		m	6	6	6	6

<sup>1</sup> Throw length (0.2 m/s) - Center

<sup>2</sup> Throw length (0.2 m/s) - Right / left

# TECHNICAL DATA

FILTERCLASS			DV 1000
Nominal capacity	ePM <sub>10</sub> 75% ePM <sub>1</sub> 55% ePM <sub>1</sub> 80%	m <sup>3</sup> /h	1000 950 900
Nominal current*		A	2,6
Nominal power consumption*		W	333
Electrical connection		V/Hz	3 x 400 V + N + PE / 50 Hz
Duct connections		mm	Ø315
Condensate drain		mm	Ø5/8
Weight, air handling unit (excl. options)		kg	210
Counterflow heat exchanger			2 x Aluminium
Supply air filter			ePM <sub>10</sub> 75%, ePM <sub>1</sub> 55% or ePM <sub>1</sub> 80%
Extract air filter			ePM <sub>10</sub> 75%
Colour, casing		RAL	9010
Electrical output factor		Cos (phi)	0,6
Recommended fuse		A	3x13
Fuse (max.)		A	3x16
Leakage current (max.)		mA	≤7
Dimensions (WxHxD)		mm	<b>H:</b> 1498 x 424 x 1384 <b>S:</b> 1512 x 501 x 1385
<b>ELECTRIC HEATING SURFACE</b>			
Thermal circuit breaker, aut. reset		°C	75
Thermal circuit breaker, man. reset		°C	120
Electric comfort heater output		W	2500
Current		A	10,9
<b>WATER HEATING SURFACE</b>			
Max. operating temperature		°C	90
Max. operating pressure		bar	910
Heat output		W	4099
Connection dimension			1/2" (DN 15)
Materials pipes/fins			copper / aluminium
Open/close time, motor valve		s	60
<b>CONDENSATE PUMP</b>			
Maximum capacity		l/h	10
Maximum lift height		m	6

# TECHNICAL DATA

		<b>CC 300</b>	<b>CC 500</b>	<b>CC 800</b>	<b>CC 1000</b>
Nominal cooling capacity*	W	2450**	3280	5240	6450
Min. cooling capacity*	W	421	820	990	1120
Nominal EER		4,01	3,16	4,72	4,45
Max. airflow	m <sup>3</sup> /h	260	500	650	900
Min. airflow***	m <sup>3</sup> /h	150	250	260	360
Supply voltage for all cooling:	1 x 230 V + N + PE / 50 Hz				
Nominal electrical output	W	617	1038	1110	1449
Nominal current strength	A	3,8	6,4	6,8	8,9
Electrical output factor		0,7	0,71	0,71	0,71
Max. leakage current	mA	3,0	2,0	2,0	2,0
Coolant		R134a	R410a	R410a	R410a
Filling	g	300	480	820	770
Duct connection dia.	mm	Ø200	Ø250	Ø315	Ø315
Drain hose, internal/external diameter	mm	Ø8/12	Ø8/12	Ø8/12	Ø8/12
Energy class		A <sup>++</sup>	A <sup>+</sup>	A <sup>+++</sup>	A <sup>+++</sup>
Weight	kg	61	82,8	100,7	85
Dimensions incl. unit (WxHxD)	mm	1274 x 333 x 972	1600 x 439 x 1185	1910 x 474 x 1321	1498 x 424 x 1898

\* Measured according to EN 308 and EN 14825 at max. airflow with ePM<sub>10</sub> 75% filter.

\*\* Measured according to EN 308 and EN 14825 at max. airflow with ePM<sub>10</sub> 70% filter.

\*\*\* Cooling module activation.







Lined writing area consisting of 26 horizontal lines.





# FILTER STANDARD - ISO 16890

All Airmaster air handling units are delivered with filters in compliance with the standard ISO 16890.

The EN ISO 16890 test method focus on the performance of filtering in proportion to specific particle sizes.

The old test method only focused on the efficiency of filtration, without taking into consideration which specific particle size it could filtrate. This standard makes it more manageable to compare with particulate pollution in other contexts.

Table 1 shows the old classifications for EN 779:2012 compared to the new classification for EN ISO 16890.

It is not possible to translate the new classifications directly, but the table shows how Airmaster translate the classification in proportion to each other.

EN ISO 16890 use new descriptions which classify the efficiency of the filtration in proportion to the particle size.  $PM_1$ ,  $PM_{2,5}$  and  $PM_{10}$  indicates the particulate matter size in  $\mu m$ .  $10 \mu m$  is the largest particle and  $1 \mu m$  is the smallest particle. In front of the PM an e is given (ePM) which indicate the efficiency of the filtration in proportion to the specific particle size and is given in %.

For example, a filter which is classified as  $ePM_1 (>55\%)$  capture more than 55% of particle size  $1 \mu m$ .

Classification cf. EN 779:2012	Classification cf. EN ISO 16890
M5	ISO $ePM_{10} (>75\%)$
F7	ISO $ePM_1 (>55\%)$
F9	ISO $ePM_1 (>80\%)$

Tabel 1 - Filter classifications

**AIRMASTER®**

Airmaster A/S  
Industrivej 59  
DK-9600 Aars

Tel.: +45 98 62 48 22  
info@airmaster-as.com  
www.airmaster-as.com